



## Product Model Number

CKO-CH15-045021-1601

### ✓ Model Number Definitions

**CKO-XXXX-XXXXXX-XXXX**



- A. Chun Kuang Optics Corp. Product
- B. Product Type: product abbreviation  
Ex:  
CH→CoB High Intensity  
CC→CoB Compact  
CS→Soft Shading for CoB LED  
HC→Holder for CoB LED

- C. Identity Code
- D. Lens / Fixture Size  
Ex: 075026=Φ75mm / Thickness=26mm (round up)
- E. Serial Numbers

The lens datasheet is applicable for **Philips LED**, that manufactured by Chun Kuang Optics Corp.

### ✓ Dimensions (mm) : Φ45 x 20.9

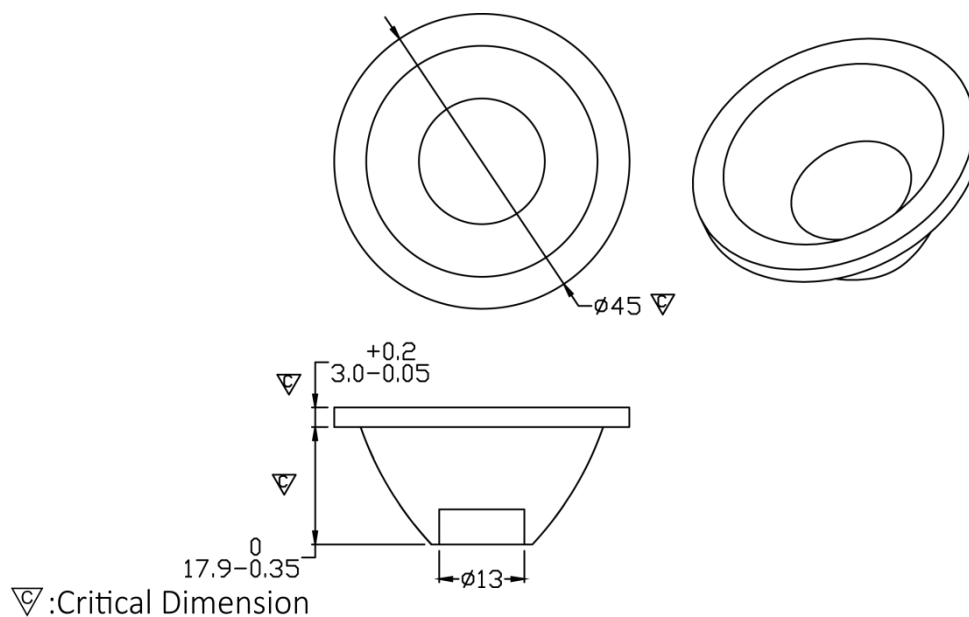



✓ Optical Characteristics – Angle Performances

Philips	LED LES (mm)	FWHM (degrees)	Field Angle (degrees)
Fortimo SLM 1202 L06 G7	Φ6.5	15°	34°
Fortimo SLM 1202 L06 G6	Φ6.5	16°	36°
Fortimo SLM 1203 L09 G6	Φ9	21°	45°
Fortimo SLM 1203 L09 G6_DL	Φ9	19°	45°
Fortimo SLM 1203 L09 G6_PI	Φ9	19°	45°
Fortimo SLM PW 1204 L09 G7	Φ9	21°	46°
Fortimo SLM 1201 L09 G7N	Φ9.8	21°	48°
Fortimo SLM 1202 L09 G7N	Φ9.8	23°	50°
Fortimo SLM 1204 L09 G7N	Φ9.8	22°	49°



## Optical Characteristics

Model Number	CKO-CH15-045021-1601		
LED	Fortimo SLM 1202 L06 G7		
LES / LED Size	Φ 6.5 mm		
FWHM (D50)	15°		
Field Angle (D10)	34°		
H (distance)	2.5mm		
Dimension	Φ =45 mm, Thickness=20.9 mm		
Luminous Flux	889 lm	Measured @ 7 W	
Material	PC / UL94V2		

## cd/klm

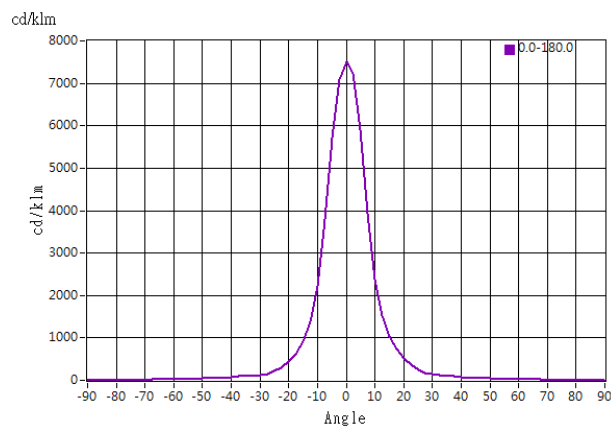

## Illuminance At Distances

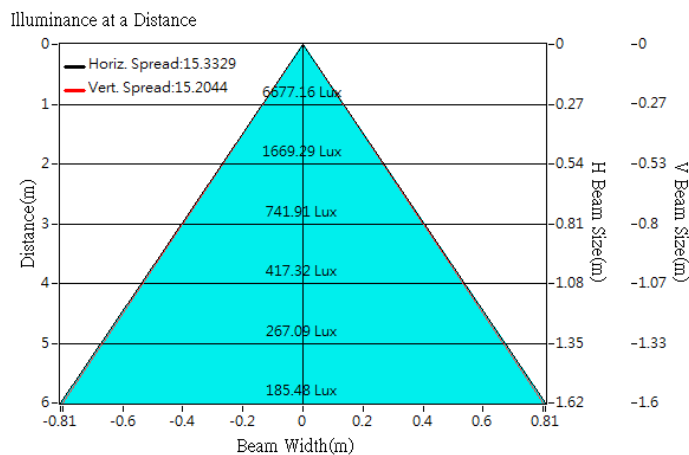





## Optical Characteristics

Model Number	CKO-CH15-045021-1601		
LED	Fortimo SLM 1202 L06 G6		
LES / LED Size	Φ 6.5 mm		
FWHM (D50)	16°		
Field Angle (D10)	36°		
H (distance)	2.5mm		
Dimension	Φ =45 mm, Thickness=20.9 mm		
Luminous Flux	897 lm	Measured @ 7.0 W	
Material	PC / UL94V2		

## cd/klm

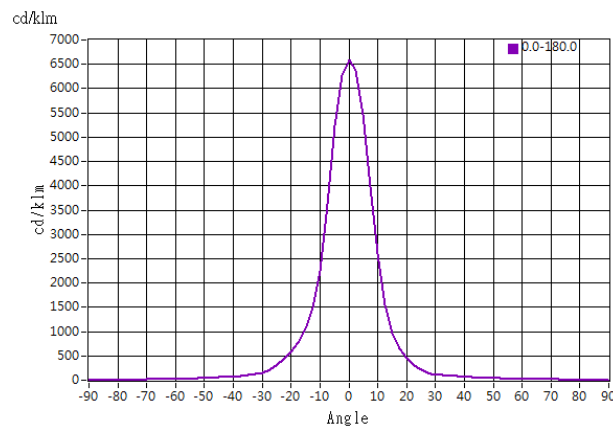

## Illuminance At Distances

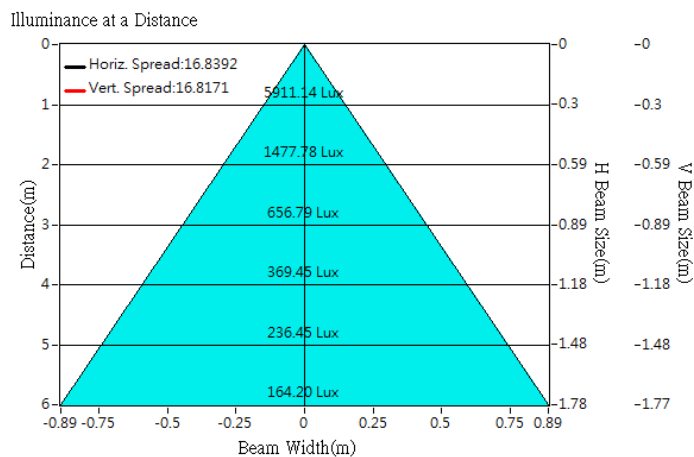



## Optical Characteristics

Model Number	CKO-CH15-045021-1601		
LED	Fortimo SLM 1203 L09 G6		
LES / LED Size	Φ 9 mm		
FWHM (D50)	21°		
Field Angle (D10)	45°		
H (distance)	2.5mm		
Dimension	Φ =45 mm, Thickness=20.9 mm		
Luminous Flux	1279 lm	Measured @ 10.4 W	
Material	PC / UL94V2		

## cd/klm

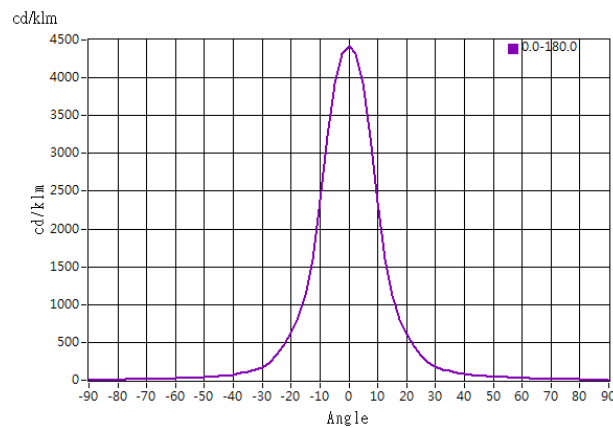

## Illuminance At Distances

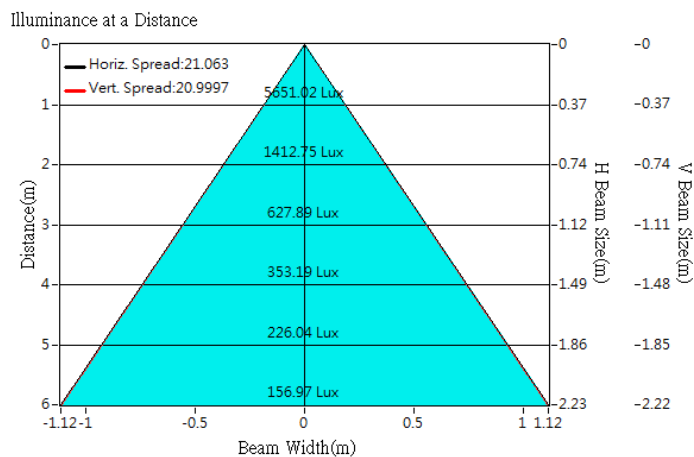



## Optical Characteristics

Model Number	CKO-CH15-045021-1601		
LED	Fortimo SLM 1203 L09 G6_DL		
LES / LED Size	Φ 9 mm		
FWHM (D50)	19°		
Field Angle (D10)	45°		
H (distance)	3.5mm		
Dimension	Φ =45 mm, Thickness=20.9 mm		
Luminous Flux	1213 lm	Measured @ 10.4 W	
Material	PC / UL94V2		

## cd/klm

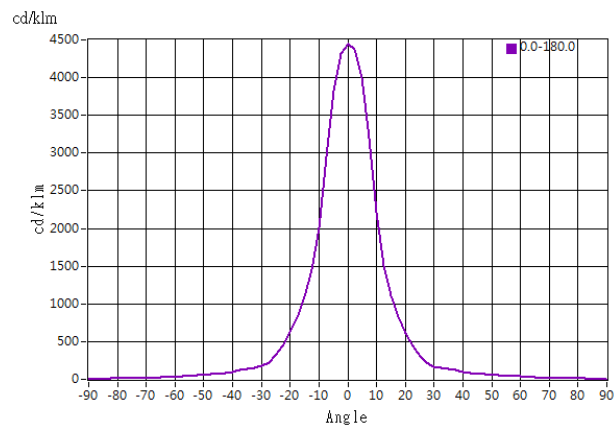

## Illuminance At Distances

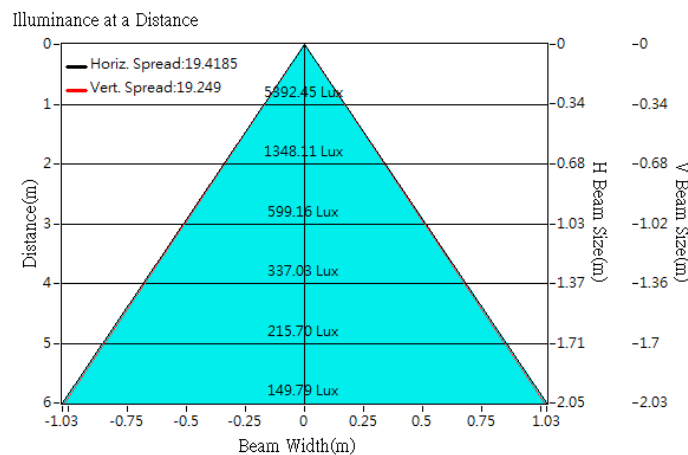



## Optical Characteristics

Model Number	CKO-CH15-045021-1601		<p>"H" definition</p>
LED	Fortimo SLM 1203 L09 G6_PI		
LES / LED Size	Φ 9 mm		
FWHM (D50)	19°		
Field Angle (D10)	45°		
H (distance)	3.5mm		
Dimension	Φ =45 mm, Thickness=20.9 mm		
Luminous Flux	1213 lm	Measured @ 10.4 W	
Material	PC / UL94V2		

## cd/klm

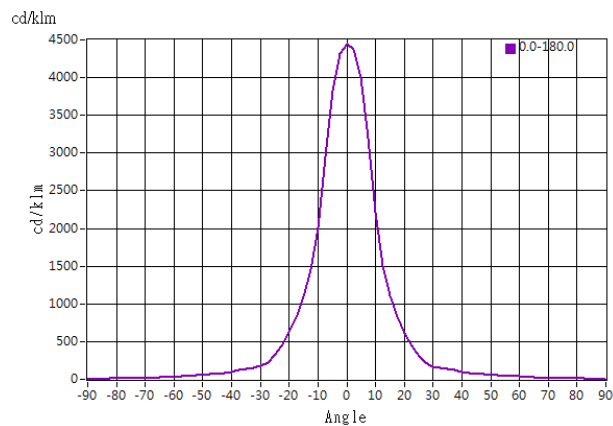

## Illuminance At Distances

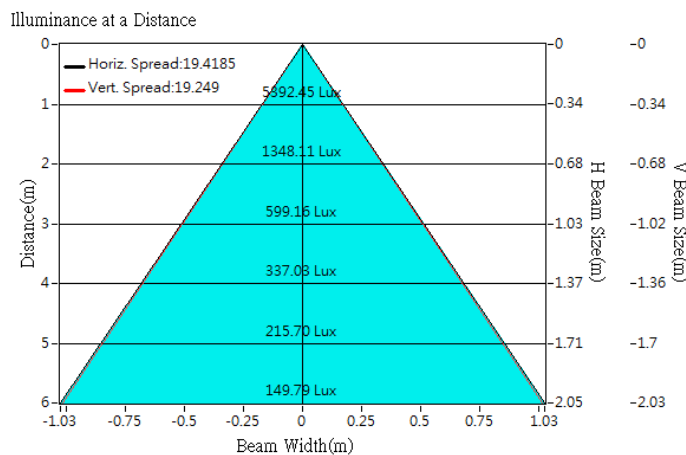





## Optical Characteristics

Model Number	CKO-CH15-045021-1601		
LED	Fortimo SLM PW 1204 L09 G7		
LES / LED Size	Φ 9 mm		
FWHM (D50)	21°		
Field Angle (D10)	46°		
H (distance)	2.5mm		
Dimension	Φ =45 mm, Thickness=20.9 mm		
Luminous Flux	2064 lm	Measured @ 21.6 W	
Material	PC / UL94V2		

## cd/klm

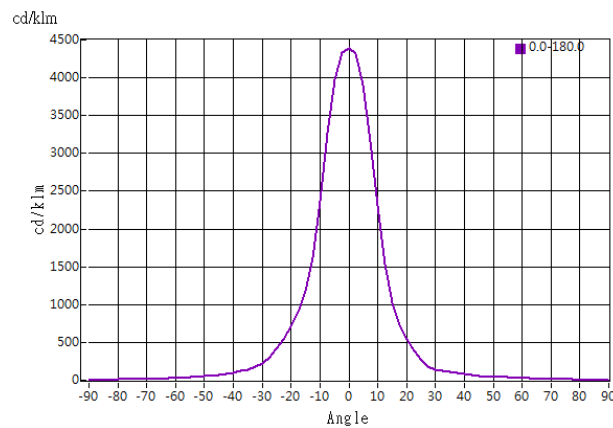

## Illuminance At Distances

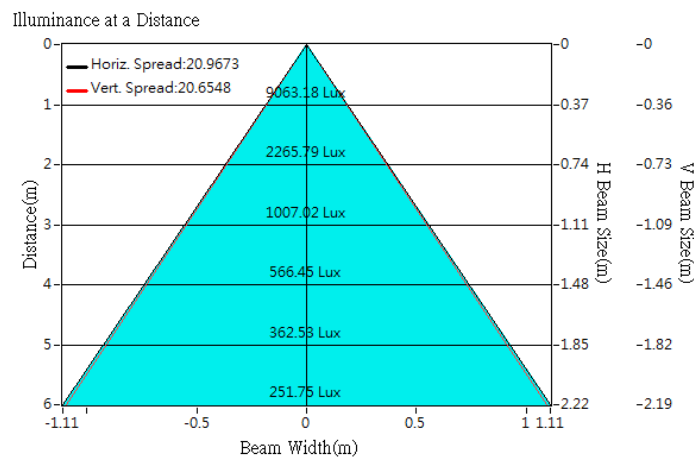





## Optical Characteristics

Model Number	CKO-CH15-045021-1601		
LED	Fortimo SLM 1201 L09 G7N		
LES / LED Size	Φ 9.8 mm		
FWHM (D50)	21°		
Field Angle (D10)	48°		
H (distance)	2.5mm		
Dimension	Φ =45 mm, Thickness=20.9 mm		
Luminous Flux	459 lm	Measured @ 3.0 W	
Material	PC / UL94V2		

## cd/klm

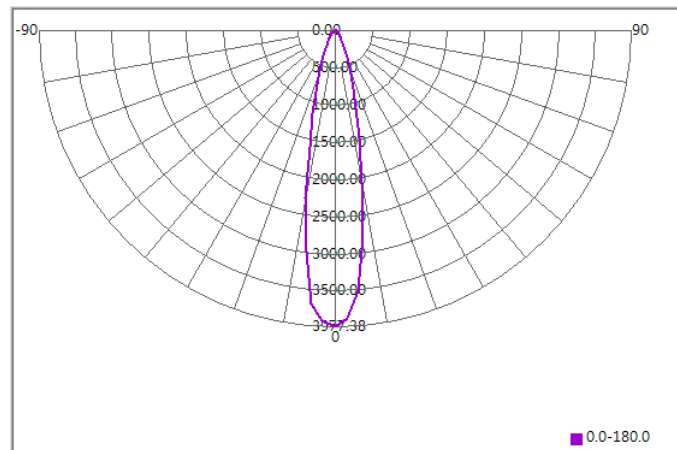

## Illuminance At Distances

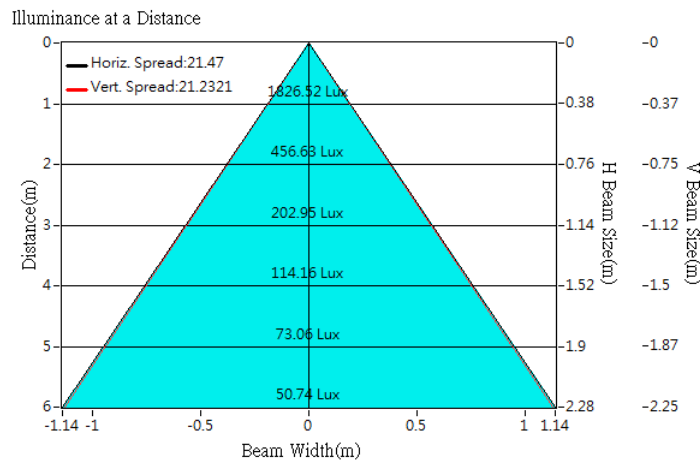



## Optical Characteristics

Model Number	CKO-CH15-045021-1601		<p>"H" definition</p> <p>LES</p> <p>CoB</p>
LED	Fortimo SLM 1202 L09 G7N		
LES / LED Size	Φ 9.8 mm		
FWHM (D50)	23°		
Field Angle (D10)	50°		
H (distance)	2.5mm		
Dimension	Φ =45 mm, Thickness=20.9 mm		
Luminous Flux	878 lm	Measured @ 6.1 W	
Material	PC / UL94V2		

## cd/klm

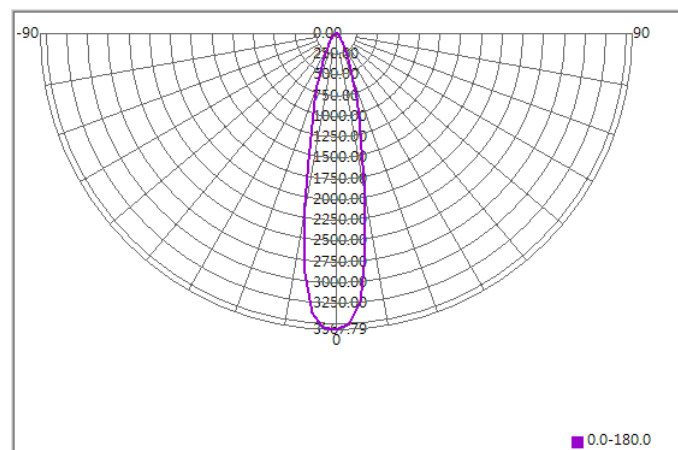

## Illuminance At Distances

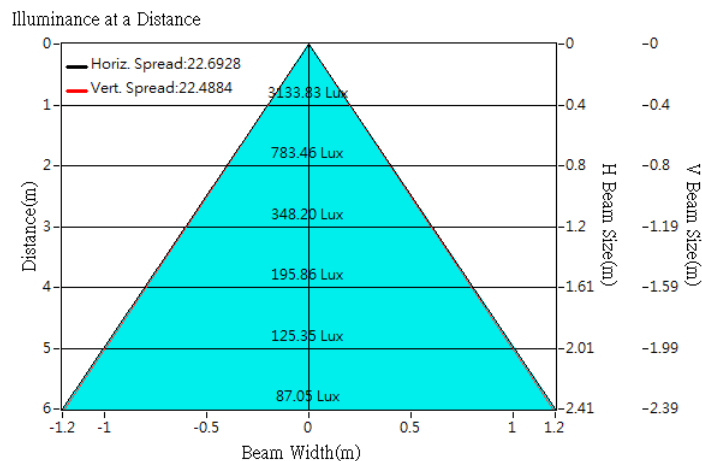



## Optical Characteristics

Model Number	CKO-CH15-045021-1601		<p>"H" definition</p> <p>LES CoB</p>
LED	Fortimo SLM 1204 L09 G7N		
LES / LED Size	Φ 9.8 mm		
FWHM (D50)	22°		
Field Angle (D10)	49°		
H (distance)	2.5mm		
Dimension	Φ =45 mm, Thickness=20.9 mm		
Luminous Flux	1723 lm	Measured @ 12.2 W	
Material	PC / UL94V2		

## cd/klm

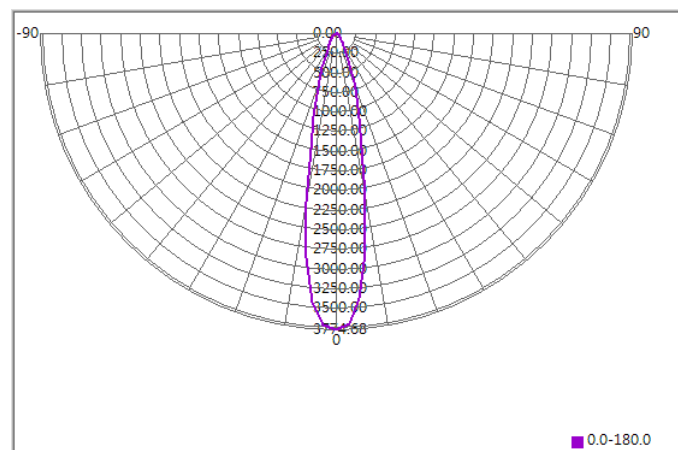

## Illuminance At Distances

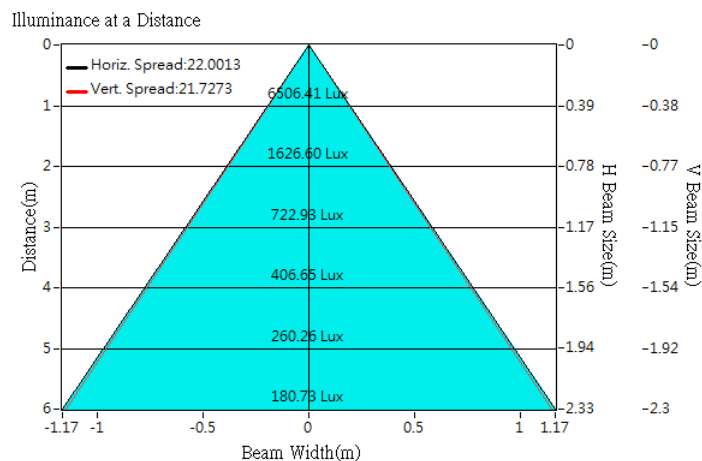





## Lens Accessories - CoB Holder

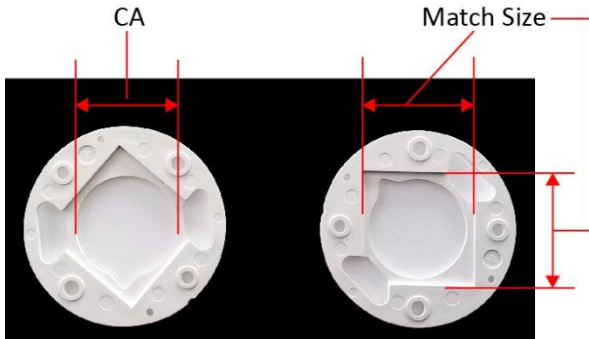

Example of LES Area & LED Size Dimension Locations

Product Model	Match Size (mm)	CA (mm)	Material	Applicability
CKO-HC14-161911-0501	16.3 x 19.3	Φ 11.9	PBT	<b>Philips 1202</b>
CKO-HC14-161911-0501	16.3 x 19.3	Φ 11.9	PBT	<b>Philips 1203</b>
CKO-HC14-202419-0502	20.3 x 24.3	Φ 19.2	PBT	<b>Philips 1204</b>
CKO-HC14-202419-0502	20.3 x 24.3	Φ 19.2	PBT	<b>Philips 1205</b>