



Product Model Number

CKO-CH15-045021-1603

✓ Model Number Definitions

CKO-XXXX-XXXXXX-XXXX



- A. Chun Kuang Optics Corp. Product
- B. Product Type: product abbreviation
Ex:
CH→CoB High Intensity
CC→CoB Compact
CS→Soft Shading for CoB LED
HC→Holder for CoB LED

- C. Identity Code
- D. Lens / Fixture Size
Ex: 075026=Φ75mm / Thickness=26mm (round up)
- C. Serial Numbers

The lens datasheet is applicable for **Luminus LED**, that manufactured by Chun Kuang Optics Corp.

✓ Dimensions (mm) : Φ45 x 20.9

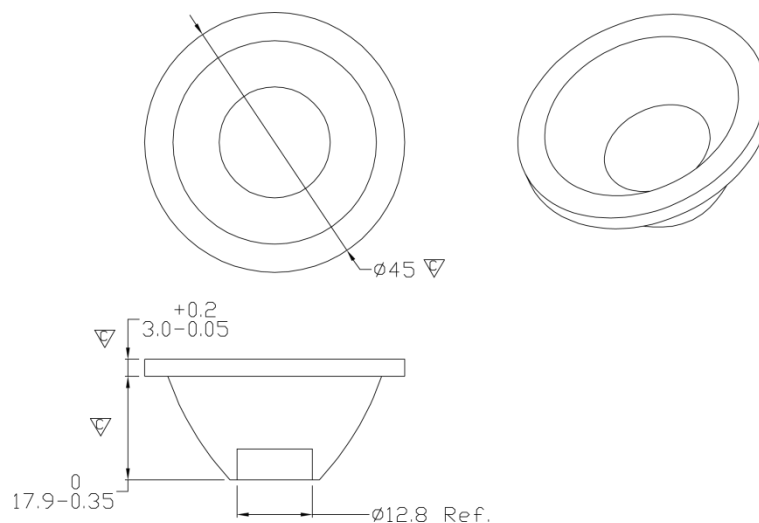

▽:Critical Dimension



Optical Characteristics

Model Number	CKO-CH15-045021-1603	<p>"H" definition</p>
LED	CXM-3-AC40	
LES / LED Size	Φ 3.5 mm	
FWHM (D50)	15°	
Field Angle (D10)	33°	
H (distance)	2.5mm	
Dimension	Φ =45 mm, Thickness=20.9 mm	
Luminous Flux	296 lm	
Material	PC / UL94V2	

cd/klm

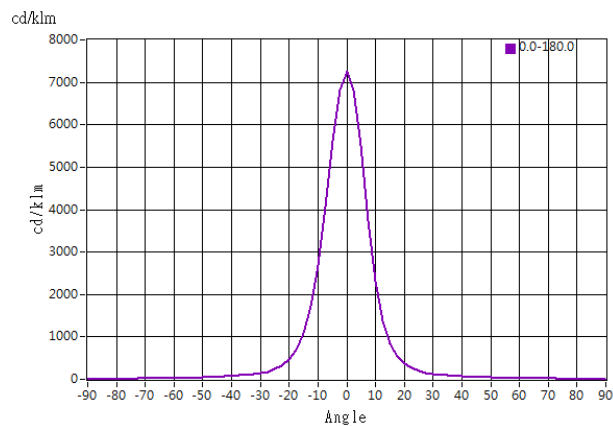

Illuminance At Distances

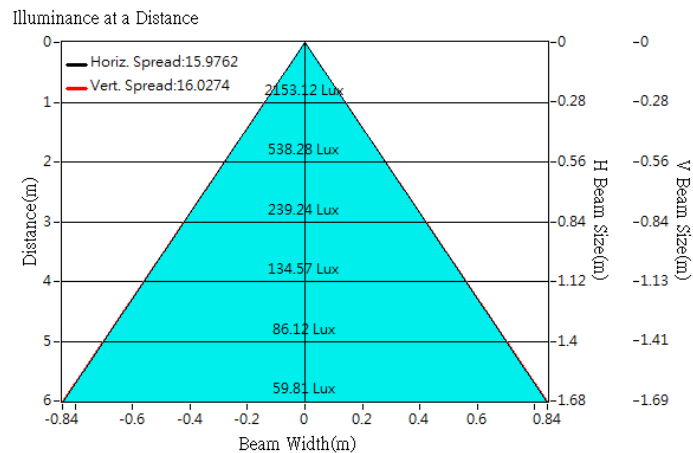



Optical Characteristics

Model Number	CKO-CH15-045021-1603	<p>"H" definition</p>
LED	CXM-4-AC40	
LES / LED Size	Φ 4.5 mm	
FWHM (D50)	17°	
Field Angle (D10)	37°	
H (distance)	2.5mm	
Dimension	Φ =45 mm, Thickness=20.9 mm	
Luminous Flux	462 lm	
Material	PC / UL94V2	

cd/klm

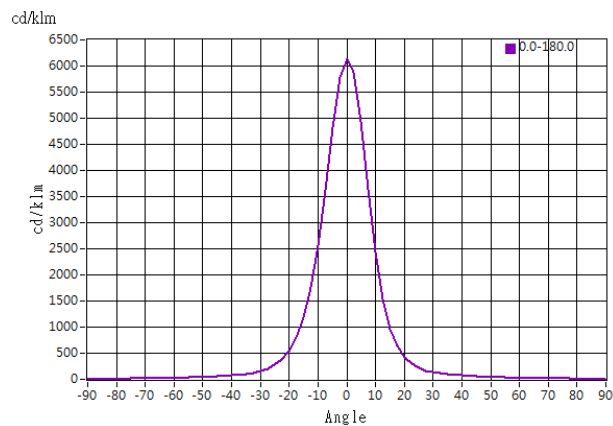

Illuminance At Distances

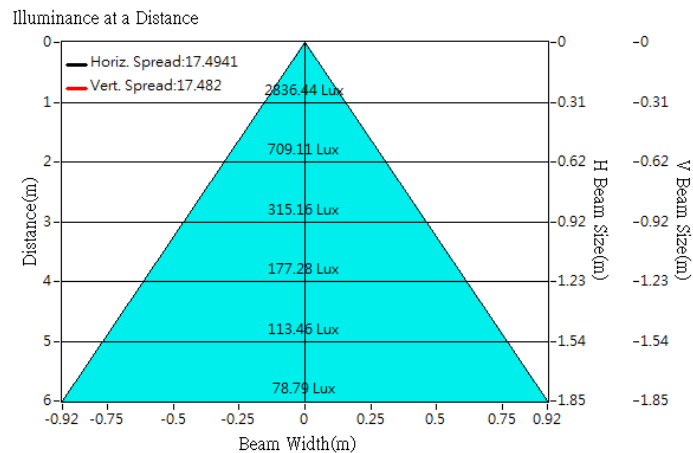



Optical Characteristics

Model Number	CKO-CH15-045021-1603	<p>"H" definition</p>
LED	CXM-6-AC40	
LES / LED Size	Φ 6.3 mm	
FWHM (D50)	21°	
Field Angle (D10)	47°	
H (distance)	2.5mm	
Dimension	Φ =45 mm, Thickness=20.9 mm	
Luminous Flux	766 lm	
Material	PC / UL94V2	

cd/klm

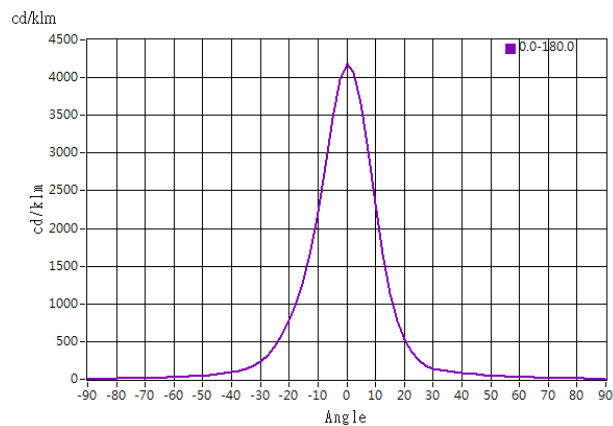

Illuminance At Distances

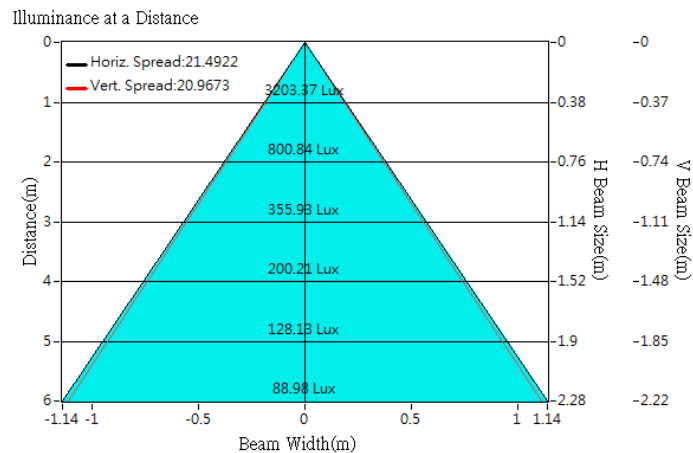



Optical Characteristics

Model Number	CKO-CH15-045021-1603	<p>"H" definition</p>
LED	CXM-9-AC30	
LES / LED Size	Φ 9.6 mm	
FWHM (D50)	27°	
Field Angle (D10)	57°	
H (distance)	2.5mm	
Dimension	Φ =45 mm, Thickness=20.9 mm	
Luminous Flux	1353 lm Measured @ 12.1 W	
Material	PC / UL94V2	

cd/klm

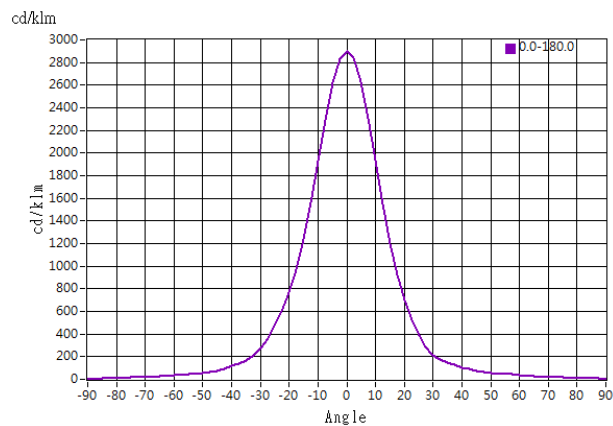

Illuminance At Distances

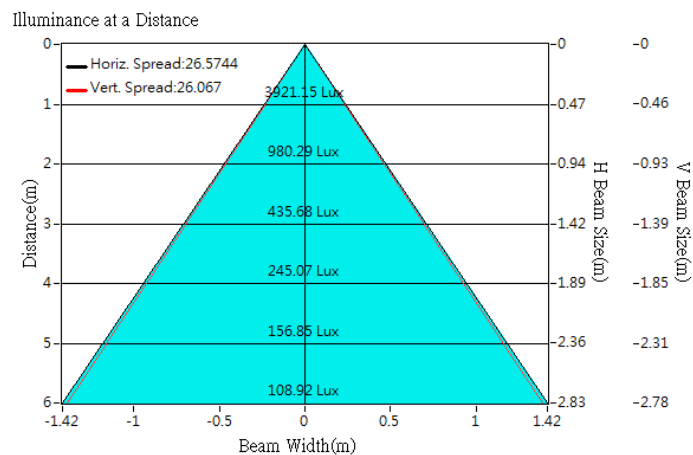



Optical Characteristics

Model Number	CKO-CH15-045021-1603	<p>"H" definition</p>
LED	CXM-9-AC40	
LES / LED Size	Φ 9.8 mm	
FWHM (D50)	27°	
Field Angle (D10)	58°	
H (distance)	2.5mm	
Dimension	Φ =45 mm, Thickness=20.9 mm	
Luminous Flux	1335 lm	
Material	PC / UL94V2	

cd/klm

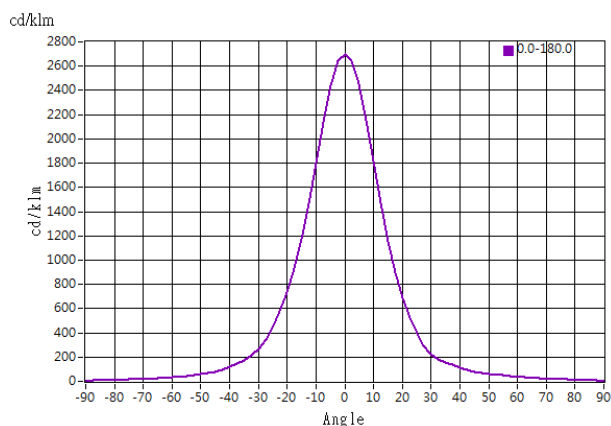

Illuminance At Distances

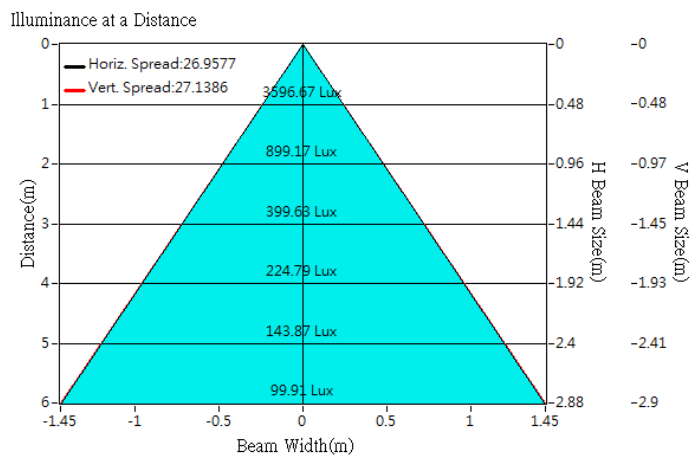



Optical Characteristics

Model Number	CKO-CH15-045021-1603	<p>"H" definition</p>
LED	CXM-11-AC30	
LES / LED Size	Φ 11.7 mm	
FWHM (D50)	30°	
Field Angle (D10)	68°	
H (distance)	2.5mm	
Dimension	Φ =45 mm, Thickness=20.9 mm	
Luminous Flux	1591 lm	
Material	PC / UL94V2	

cd/klm

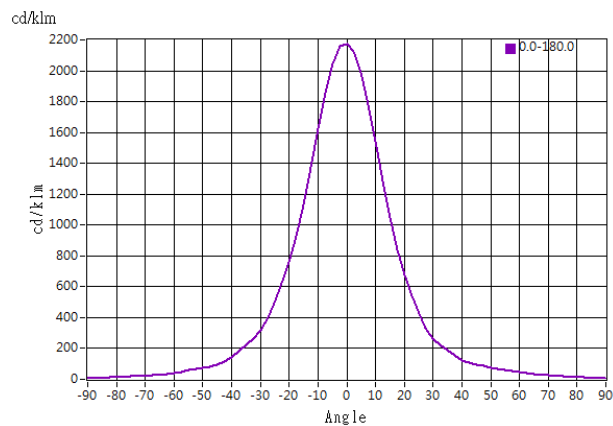

Illuminance At Distances

