



Product Model Number

CKO-CH15-045021-1603

✓ Model Number Definitions

CKO-XXXX-XXXXXX-XXXX



- A. Chun Kuang Optics Corp. Product
- B. Product Type: product abbreviation
Ex:
CH→CoB High Intensity
CC→CoB Compact
CS→Soft Shading for CoB LED
HC→Holder for CoB LED

- C. Identity Code
- D. Lens / Fixture Size
Ex: 075026=Φ75mm / Thickness=26mm (round up)
- C. Serial Numbers

The lens datasheet is applicable for **Philips LED**, that manufactured by Chun Kuang Optics Corp.

✓ Dimensions (mm) : Φ45 x 20.9

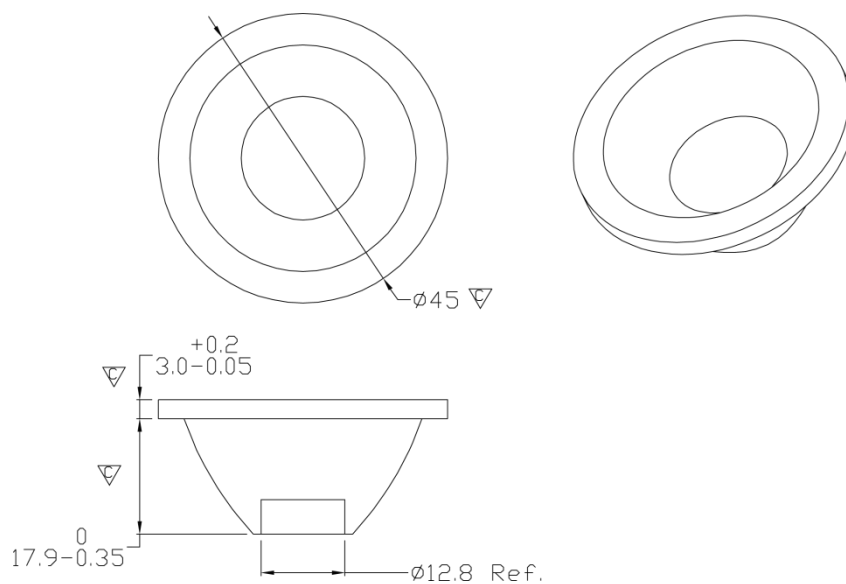

▽:Critical Dimension



✓ **Optical Characteristics – Angle Performances**

Philips	LED LES (mm)	FWHM (degrees)	Field Angle (degrees)
Fortimo SLM 1202 L06 G7	Φ6.5	20°	43°
Fortimo SLM 1202 L06 G6	Φ6.5	21°	46°
Fortimo SLM 1203 L09 G6	Φ9	25°	53°
Fortimo SLM 1203 L09 G6_DL	Φ9	24°	53°
Fortimo SLM 1203 L09 G6_PI	Φ9	24°	53°
Fortimo SLM PW 1204 L09 G7	Φ9	25°	54°
Fortimo SLM 1201 L09 G7N	Φ9.8	26°	57°
Fortimo SLM 1202 L09 G7N	Φ9.8	27°	58°
Fortimo SLM 1204 L09 G7N	Φ9.8	27°	58°



Optical Characteristics

Model Number	CKO-CH15-045021-1603		<p>"H" definition</p>
LED	Fortimo SLM 1202 L06 G7		
LES / LED Size	Φ 6.5 mm		
FWHM (D50)	20°		
Field Angle (D10)	43°		
H (distance)	2.5mm		
Dimension	Φ =45 mm, Thickness=20.9 mm		
Luminous Flux	822 lm	Measured @ 7 W	
Material	PC / UL94V2		

cd/klm

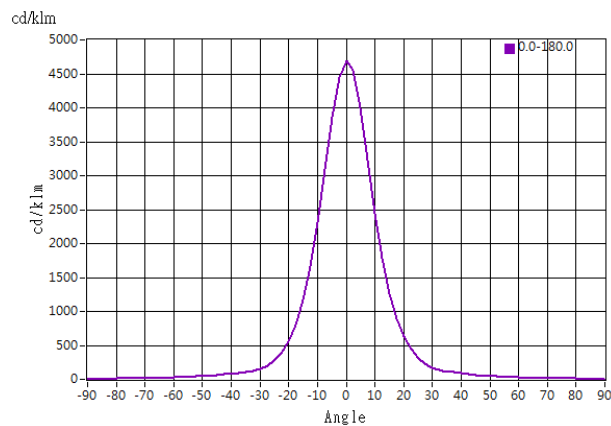

Illuminance At Distances

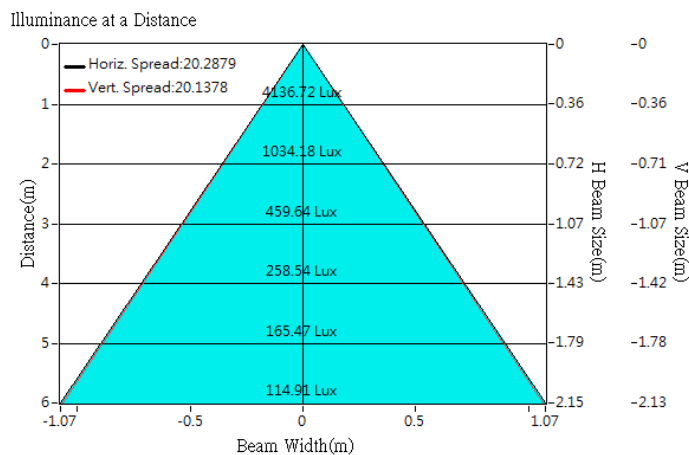



Optical Characteristics

Model Number	CKO-CH15-045021-1603		
LED	Fortimo SLM 1202 L06 G6		
LES / LED Size	Φ 6.5 mm		
FWHM (D50)	21°		
Field Angle (D10)	46°		
H (distance)	2.5mm		
Dimension	Φ =45 mm, Thickness=20.9 mm		
Luminous Flux	884 lm	Measured @ 7.0 W	
Material	PC / UL94V2		

cd/klm

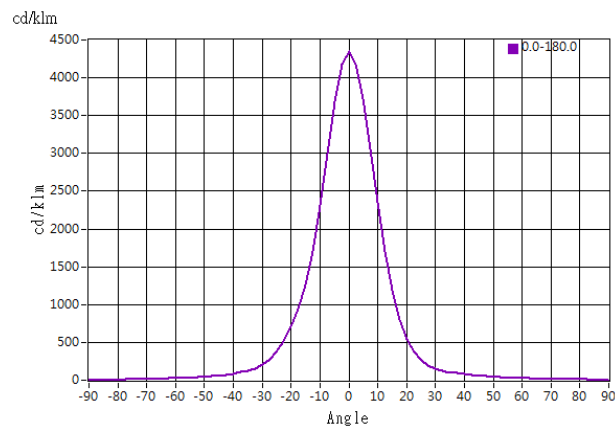

Illuminance At Distances

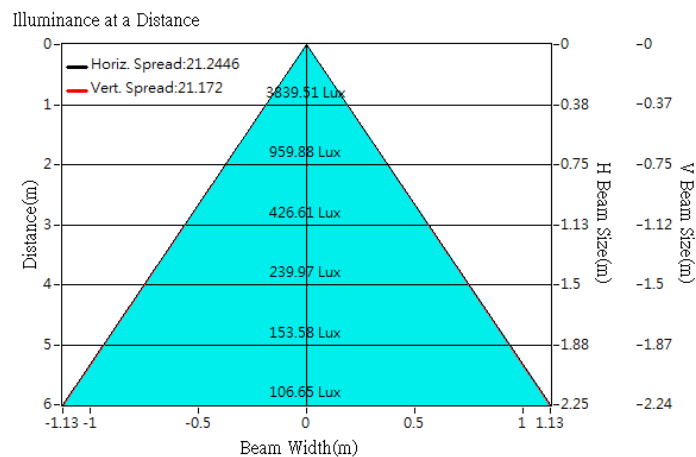



Optical Characteristics

Model Number	CKO-CH15-045021-1603		
LED	Fortimo SLM 1203 L09 G6		
LES / LED Size	Φ 9 mm		
FWHM (D50)	25°		
Field Angle (D10)	53°		
H (distance)	2.5mm		
Dimension	Φ =45 mm, Thickness=20.9 mm		
Luminous Flux	1249 lm	Measured @ 10.4 W	
Material	PC / UL94V2		

cd/klm

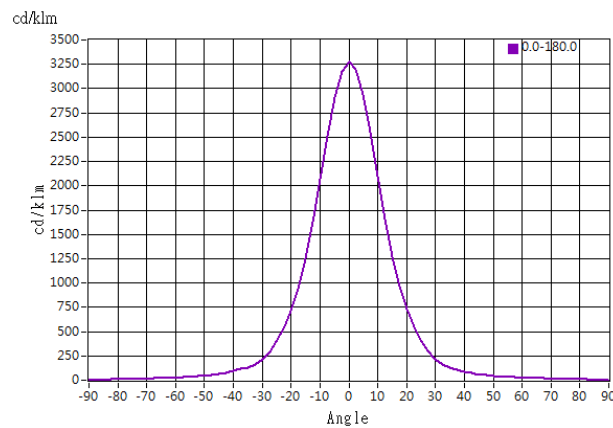

Illuminance At Distances

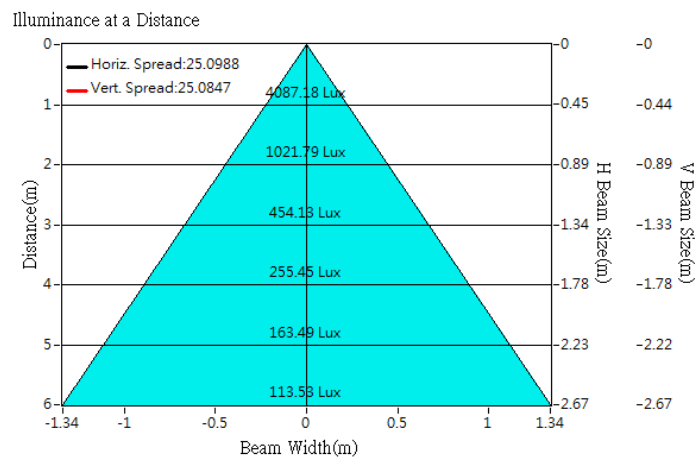



Optical Characteristics

Model Number	CKO-CH15-045021-1603		<p>"H" definition</p>
LED	Fortimo SLM 1203 L09 G6_DL		
LES / LED Size	Φ 9 mm		
FWHM (D50)	24°		
Field Angle (D10)	53°		
H (distance)	3.5mm		
Dimension	Φ =45 mm, Thickness=20.9 mm		
Luminous Flux	1207 lm	Measured @ 10.4 W	
Material	PC / UL94V2		

cd/klm

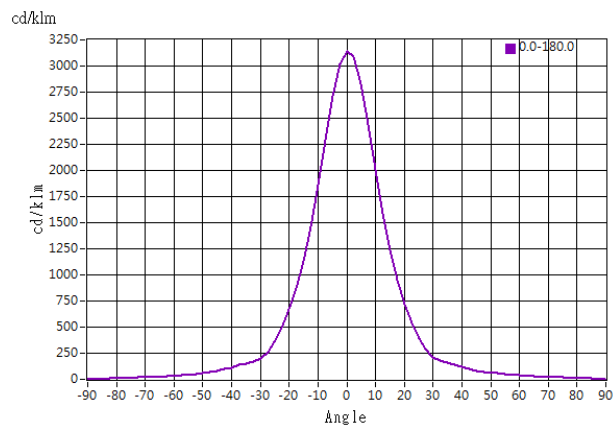

Illuminance At Distances

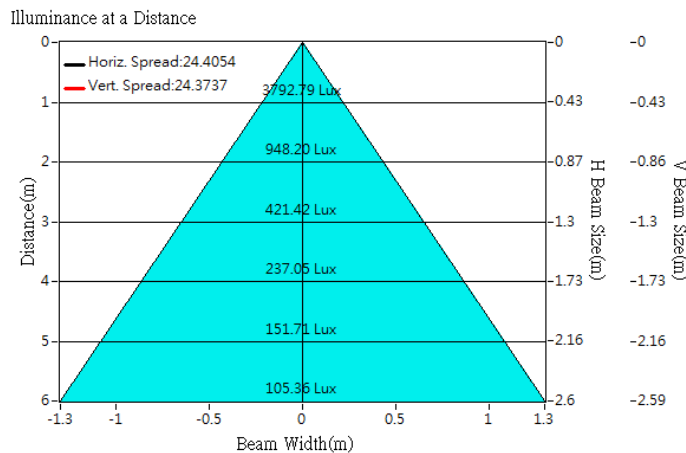



Optical Characteristics

Model Number	CKO-CH15-045021-1603		<p>"H" definition</p> <p>LES</p> <p>CoB</p>
LED	Fortimo SLM 1203 L09 G6_PI		
LES / LED Size	Φ 9 mm		
FWHM (D50)	24°		
Field Angle (D10)	53°		
H (distance)	3.5mm		
Dimension	Φ =45 mm, Thickness=20.9 mm		
Luminous Flux	1207 lm	Measured @ 10.4 W	
Material	PC / UL94V2		

cd/klm

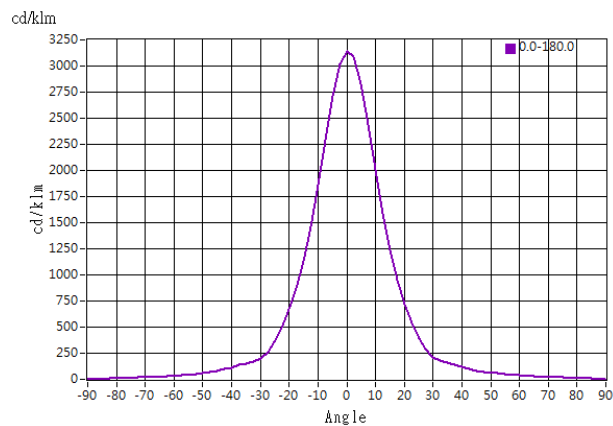

Illuminance At Distances

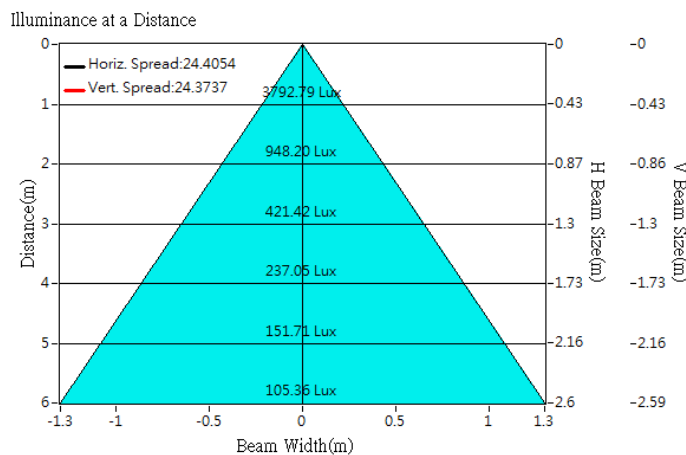



Optical Characteristics

Model Number	CKO-CH15-045021-1603		
LED	Fortimo SLM 1204 L09 G7		
LES / LED Size	Φ 9 mm		
FWHM (D50)	25°		
Field Angle (D10)	54°		
H (distance)	2.5mm		
Dimension	Φ =45 mm, Thickness=20.9 mm		
Luminous Flux	2039 lm	Measured @ 21.6 W	
Material	PC / UL94V2		

cd/klm

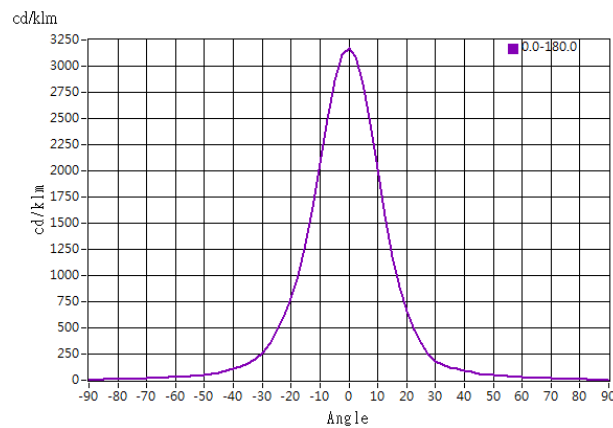

Illuminance At Distances

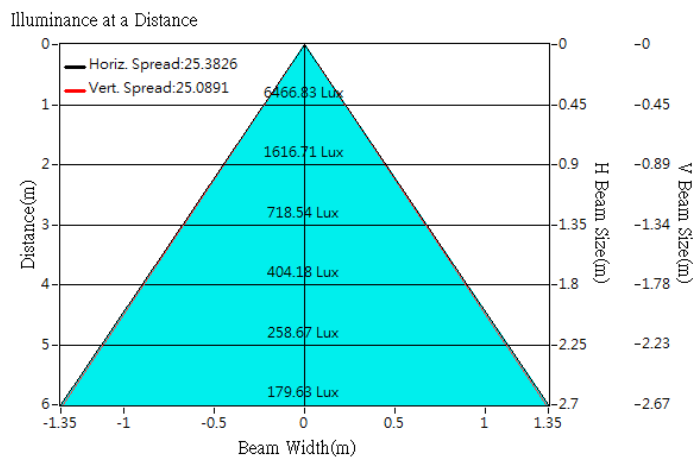



Optical Characteristics

Model Number	CKO-CH15-045021-1603		<p>"H" definition</p> <p>LES</p> <p>CoB</p> <p>"H" mm (distance)</p>
LED	Fortimo SLM 1201 L09 G7N		
LES / LED Size	Φ 9.8 mm		
FWHM (D50)	26°		
Field Angle (D10)	57°		
H (distance)	2.5mm		
Dimension	Φ =45 mm, Thickness=20.9 mm		
Luminous Flux	458 lm	Measured @ 3.0 W	
Material	PC / UL94V2		

cd/klm

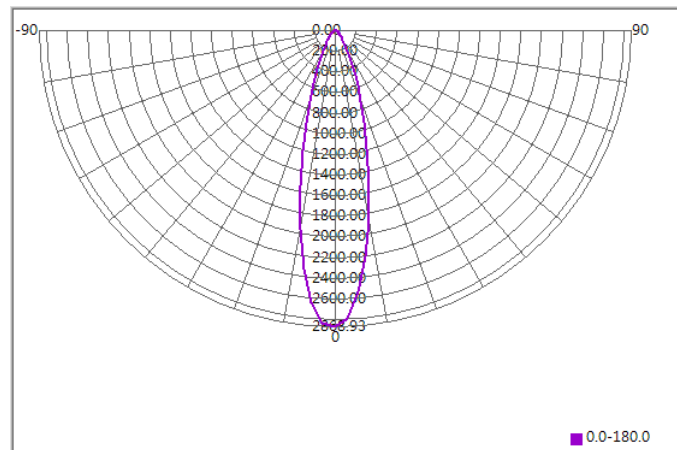

Illuminance At Distances

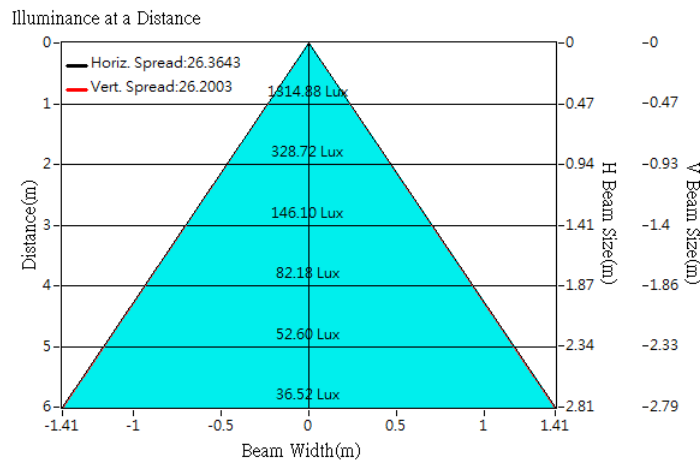



Optical Characteristics

Model Number	CKO-CH15-045021-1603		<p>"H" definition</p> <p>LES CoB</p>
LED	Fortimo SLM 1202 L09 G7N		
LES / LED Size	Φ 9.8 mm		
FWHM (D50)	27°		
Field Angle (D10)	58°		
H (distance)	2.5mm		
Dimension	Φ =45 mm, Thickness=20.9 mm		
Luminous Flux	859 lm	Measured @ 6.1 W	
Material	PC / UL94V2		

cd/klm

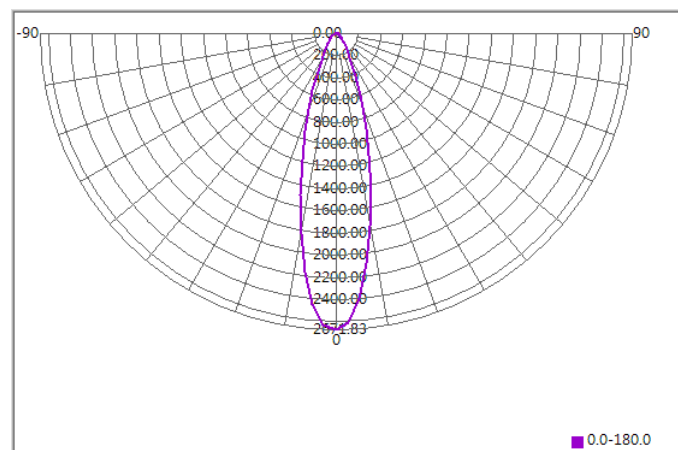

Illuminance At Distances

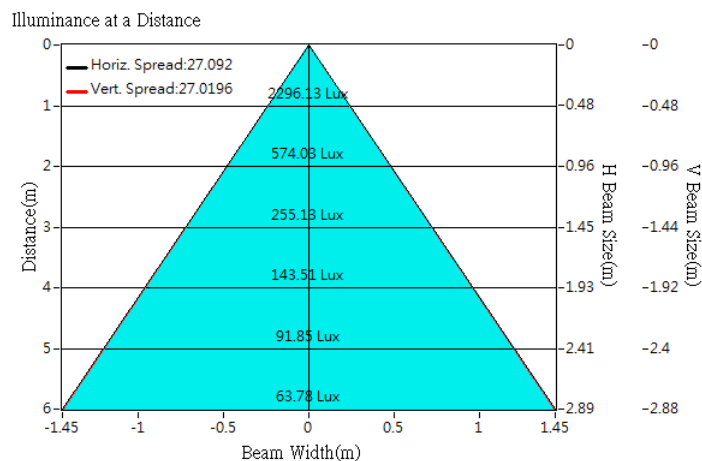



Optical Characteristics

Model Number	CKO-CH15-045021-1603		<p>"H" definition</p> <p>LES</p> <p>CoB</p>
LED	Fortimo SLM 1204 L09 G7N		
LES / LED Size	Φ 9.8 mm		
FWHM (D50)	27°		
Field Angle (D10)	58°		
H (distance)	2.5mm		
Dimension	Φ =45 mm, Thickness=20.9 mm		
Luminous Flux	1660 lm	Measured @ 12.3 W	
Material	PC / UL94V2		

cd/klm

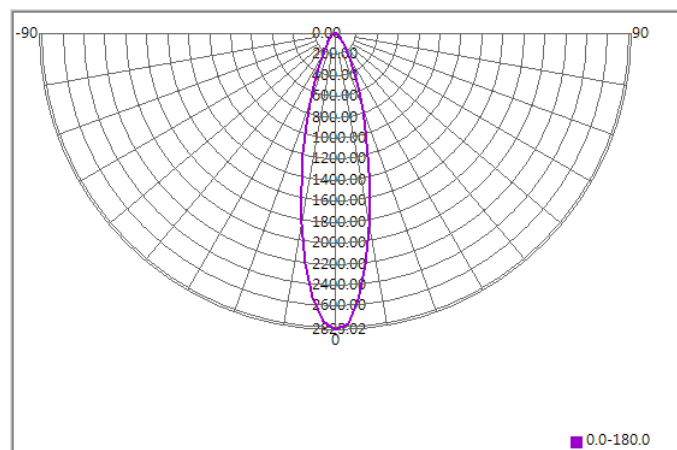

Illuminance At Distances

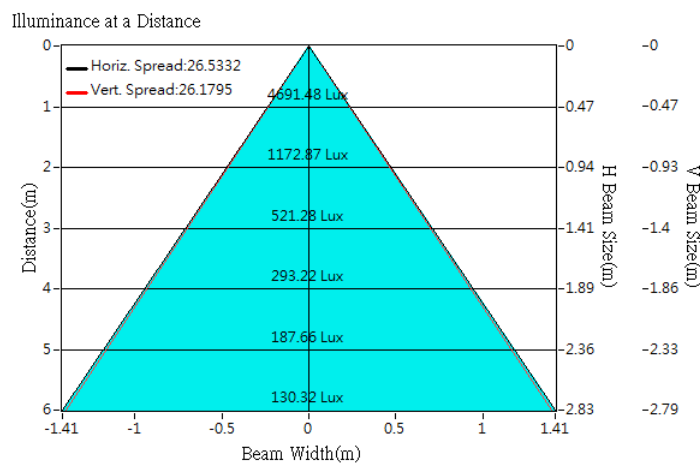



Lens Accessories - CoB Holder

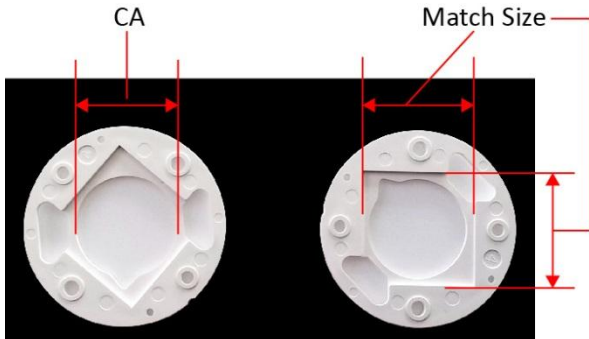

Example of LES Area & LED Size Dimension Locations

Product Model	Match Size (mm)	CA (mm)	Material	Applicability
CKO-HC14-161911-0501	16.3 x 19.3	Φ 11.9	PBT	Philips 1202
CKO-HC14-161911-0501	16.3 x 19.3	Φ 11.9	PBT	Philips 1203
CKO-HC14-202419-0502	20.3 x 24.3	Φ 19.2	PBT	Philips 1204
CKO-HC14-202419-0502	20.3 x 24.3	Φ 19.2	PBT	Philips 1205