



Product Model Number

CKO-CH15-060027-4305

✓ Model Number Definitions

CKO-XXXX-XXXXXX-XXXX



- A. Chun Kuang Optics Corp. Product
- B. Product Type: product abbreviation
Ex:
CH→CoB High Intensity
CC→CoB Compact
CS→Soft Shading for CoB LED
HC→Holder for CoB LED

- C. Identity Code
- D. Lens / Fixture Size
Ex: 075026=Φ75mm / Thickness=26mm (round up)
- C. Serial Numbers

The lens datasheet is applicable for **Luminus LED**, that manufactured by Chun Kuang Optics Corp.

✓ Dimensions (mm) : Φ60 x 26.85

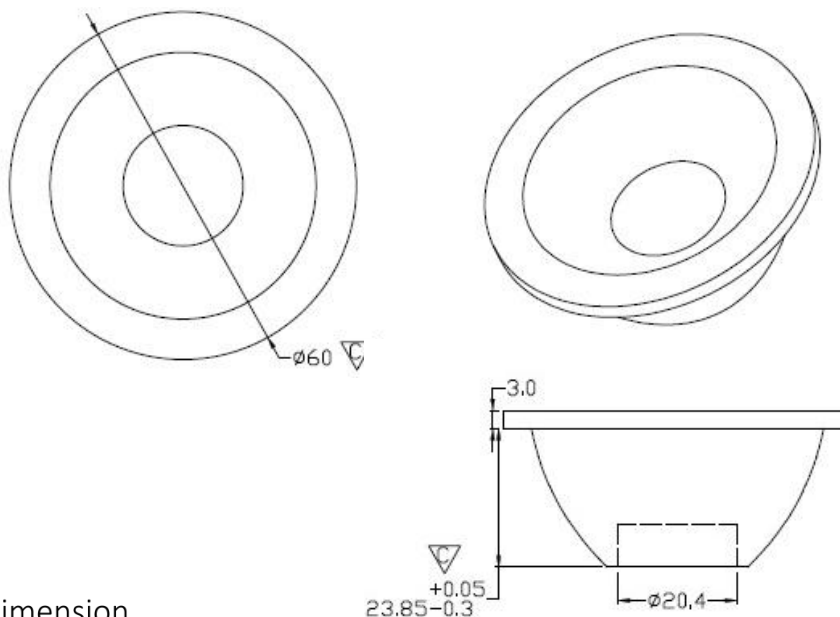

▽:Critical Dimension



✓ **Optical Characteristics – Angle Performances**

| Luminus | LED LES (mm) | FWHM (degrees) | Field Angle (degrees) |
|----------------|---------------------|-----------------------|------------------------------|
| CXM-9-AC30 | Φ9.6 | 34° | 63° |
| CXM-9-AC40 | Φ9.8 | 35° | 65° |
| CXM-11-AC30 | Φ11.7 | 36° | 67° |
| CLM-14-AC40 | Φ14.5 | 40° | 70° |
| | | | |
| | | | |
| | | | |
| | | | |
| | | | |
| | | | |
| | | | |
| | | | |
| | | | |
| | | | |
| | | | |
| | | | |
| | | | |
| | | | |
| | | | |
| | | | |
| | | | |



Optical Characteristics

| | | |
|-------------------|------------------------------|--|
| Model Number | CKO-CH15-060027-4305 | <p>"H" definition</p> <p>LES CoB</p> |
| LED | CXM-9-AC30 | |
| LES / LED Size | Φ 9.6 mm | |
| FWHM (D50) | 34° | |
| Field Angle (D10) | 63° | |
| H (distance) | 3.65mm | |
| Dimension | Φ =60 mm, Thickness=26.85 mm | |
| Luminous Flux | 1343 lm | |
| Material | PC / UL94V2 | |

cd/klm

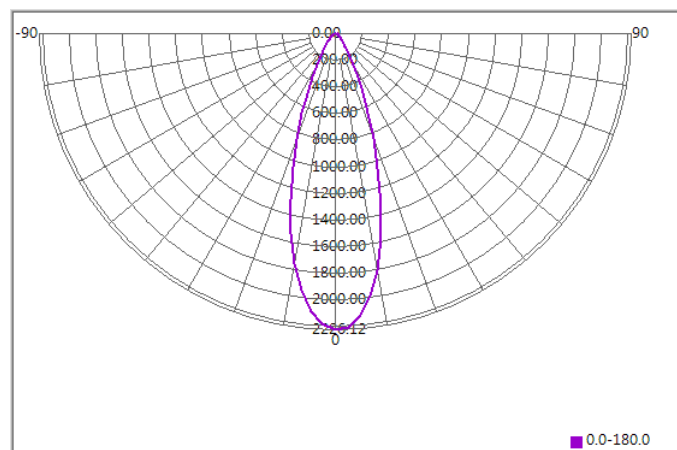

Illuminance At Distances

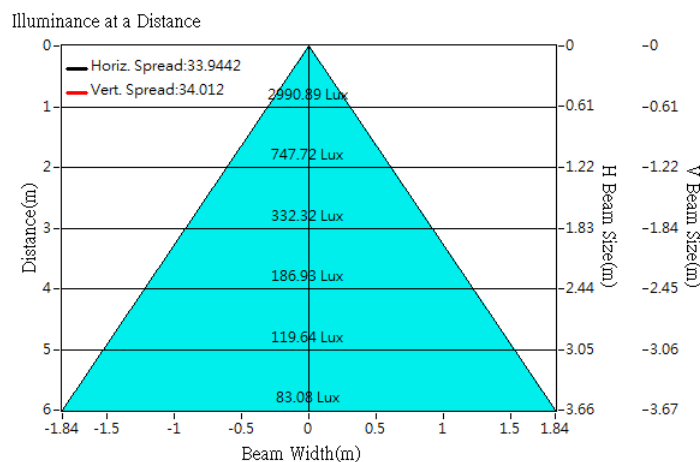



Optical Characteristics

| | | | |
|-------------------|------------------------------|-------------------|--|
| Model Number | CKO-CH15-060027-4305 | | <p>"H" definition</p> <p>LES CoB</p> |
| LED | CXM-9-AC40 | | |
| LES / LED Size | Φ 9.8 mm | | |
| FWHM (D50) | 35° | | |
| Field Angle (D10) | 65° | | |
| H (distance) | 3.65mm | | |
| Dimension | Φ =60 mm, Thickness=26.85 mm | | |
| Luminous Flux | 1346 lm | Measured @ 12.3 W | |
| Material | PC / UL94V2 | | |

cd/klm

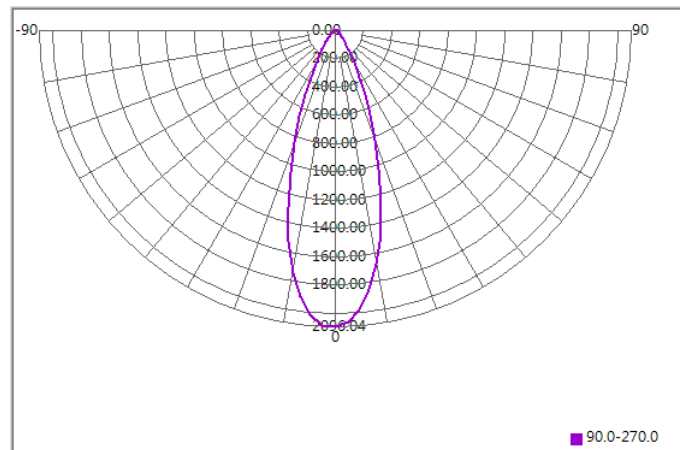

Illuminance At Distances

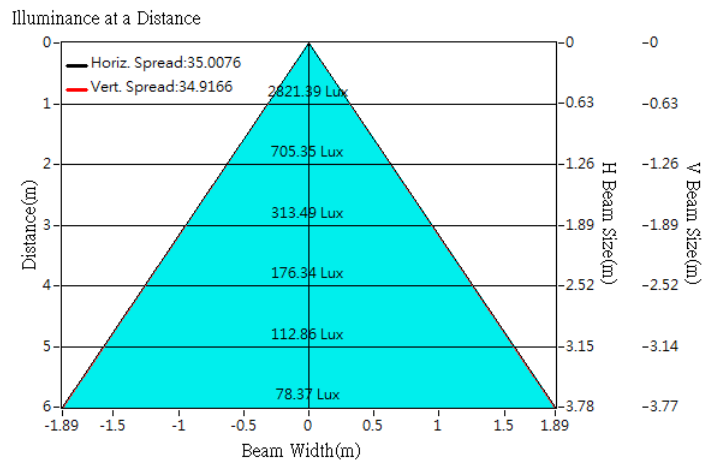



Optical Characteristics

| | | | |
|-------------------|------------------------------|-------------------|--|
| Model Number | CKO-CH15-060027-4305 | | <p>"H" definition</p> <p>LES CoB</p> |
| LED | CXM-11-AC30 | | |
| LES / LED Size | Φ 11.7 mm | | |
| FWHM (D50) | 36° | | |
| Field Angle (D10) | 67° | | |
| H (distance) | 3.65mm | | |
| Dimension | Φ =60 mm, Thickness=26.85 mm | | |
| Luminous Flux | 1642 lm | Measured @ 15.6 W | |
| Material | PC / UL94V2 | | |

cd/klm

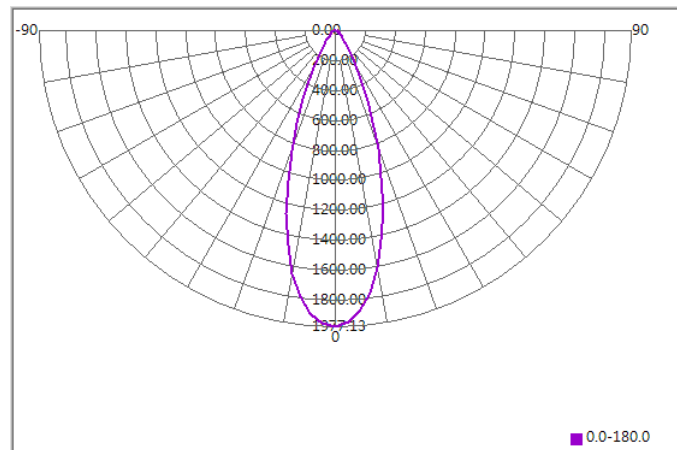

Illuminance At Distances

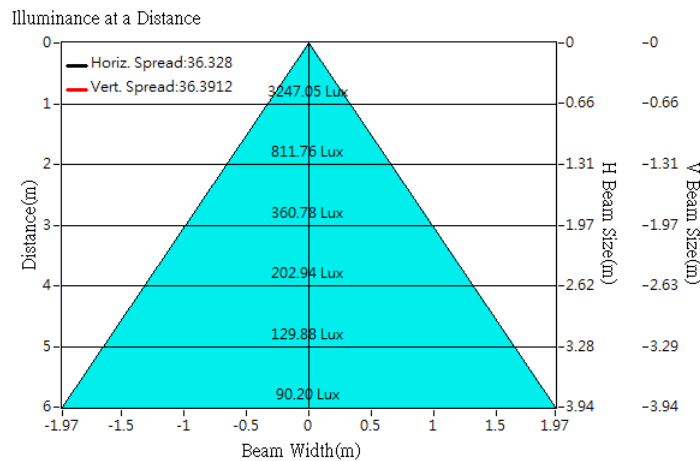



Optical Characteristics

| | | | |
|-------------------|------------------------------|-------------------|-----------------------|
| Model Number | CKO-CH15-060027-4305 | | <p>"H" definition</p> |
| LED | CLM-14-AC40 | | |
| LES / LED Size | Φ14.5 | | |
| FWHM (D50) | 40° | | |
| Field Angle (D10) | 70° | | |
| H (distance) | 3.65mm | | |
| Dimension | Φ =60 mm, Thickness=26.85 mm | | |
| Luminous Flux | 2495 lm | Measured @ 16.6 W | |
| Material | PC / UL94V2 | | |

cd/klm

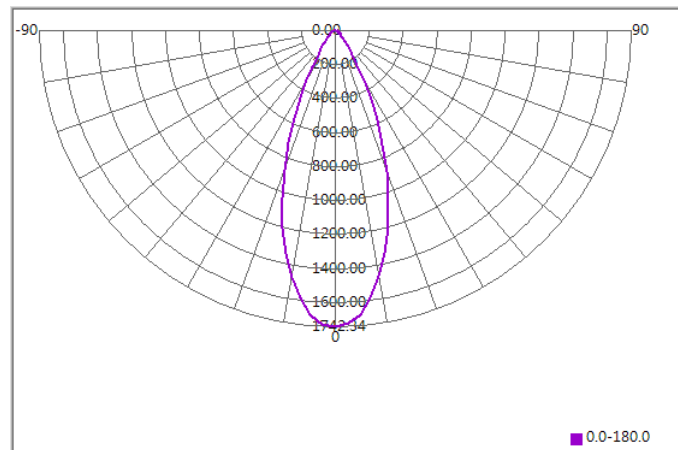

Illuminance At Distances

