



## Product Model Number

**CKO-CH15-060027-4350**

### ✓ Model Number Definitions

**CKO-XXXX-XXXXXX-XXXX**



- A. Chun Kuang Optics Corp. Product
- B. Product Type: product abbreviation  
Ex:  
CH→CoB High Intensity  
CC→CoB Compact  
CS→Soft Shading for CoB LED  
HC→Holder for CoB LED

- C. Identity Code
- D. Lens / Fixture Size  
Ex: 075026=Φ75mm / Thickness=26mm (round up)
- C. Serial Numbers

The lens datasheet is applicable for **Citizen LED**, that manufactured by Chun Kuang Optics Corp.

### ✓ Dimensions (mm) : Φ60 x 26.85

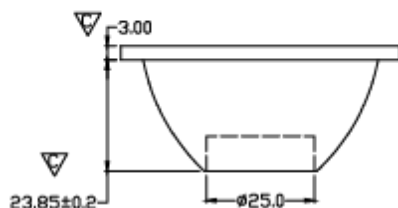
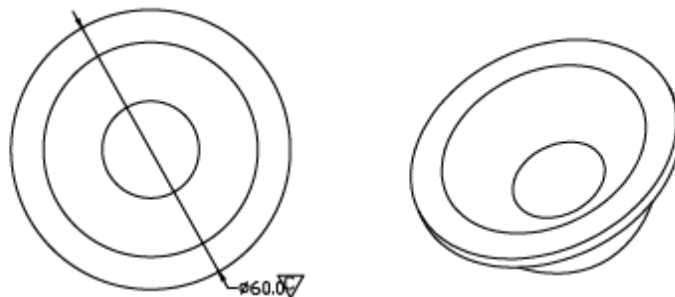

▽:Critical Dimension



✓ Optical Characteristics – Angle Performances

Citizen	LED LES (mm)	FWHM (degrees)	Field Angle (degrees)
CLU 711	Φ8.5	53°	98°
CLU 028	Φ9.8	51°	98°
CLU 026	Φ9.8	52°	99°
CLU 721	Φ11	53°	99°
CLU 038	Φ14.5	54°	101°



## Optical Characteristics

Model Number	CKO-CH15-060027-4350		<p>"H" definition</p>
LED	CLU 711		
LES / LED Size	Φ 8.5 mm		
FWHM (D50)	53°		
Field Angle (D10)	98°		
H (distance)	3.65mm		
Dimension	Φ =60 mm, Thickness=26.85 mm		
Luminous Flux	2607 lm	Measured @ 26.3 W	
Material	PC / UL94V2		

## cd/klm

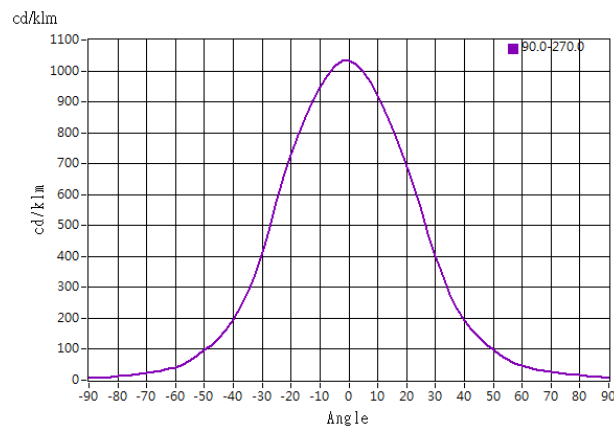

## Illuminance At Distances

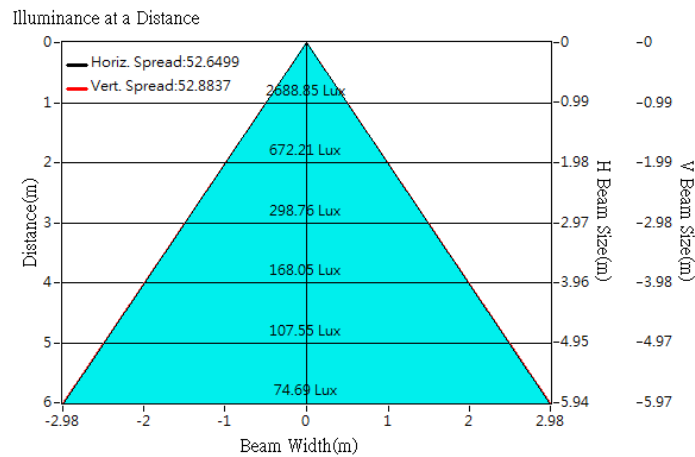



## Optical Characteristics

Model Number	CKO-CH15-060027-4350		<p>"H" definition</p>
LED	CLU 028		
LES / LED Size	Φ 9.8 mm		
FWHM (D50)	51°		
Field Angle (D10)	98°		
H (distance)	3.65mm		
Dimension	Φ =60 mm, Thickness=26.85 mm		
Luminous Flux	1539 lm	Measured @ 12.7 W	
Material	PC / UL94V2		

## cd/klm

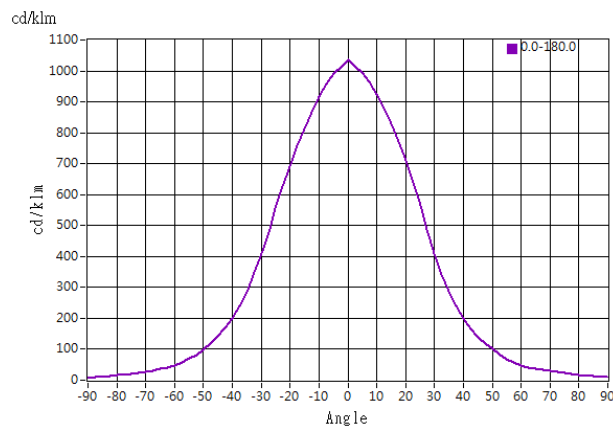

## Illuminance At Distances

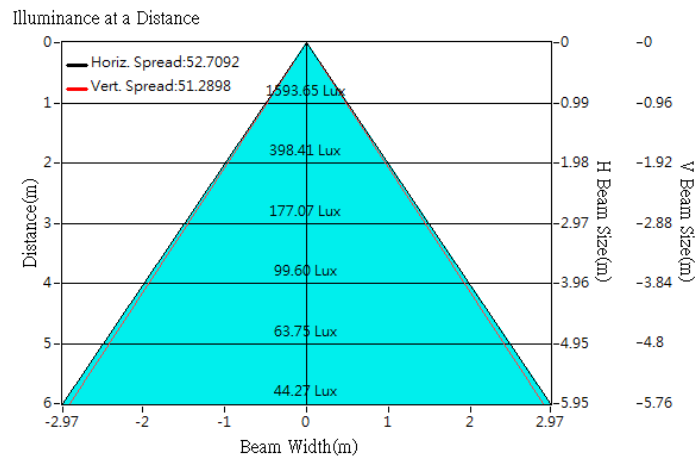

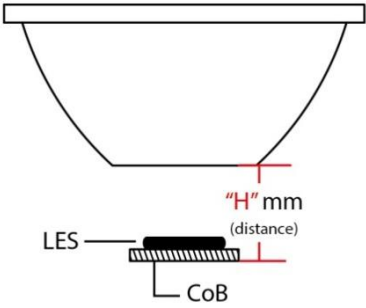

## Optical Characteristics

Model Number	CKO-CH15-060027-4350		<p>"H" definition</p> 
LED	CLU 026		
LES / LED Size	Φ 9.8 mm		
FWHM (D50)	52°		
Field Angle (D10)	99°		
H (distance)	3.65mm		
Dimension	Φ =60 mm, Thickness=26.85 mm		
Luminous Flux	1511 lm	Measured @ 12.5 W	
Material	PC / UL94V2		

## cd/klm

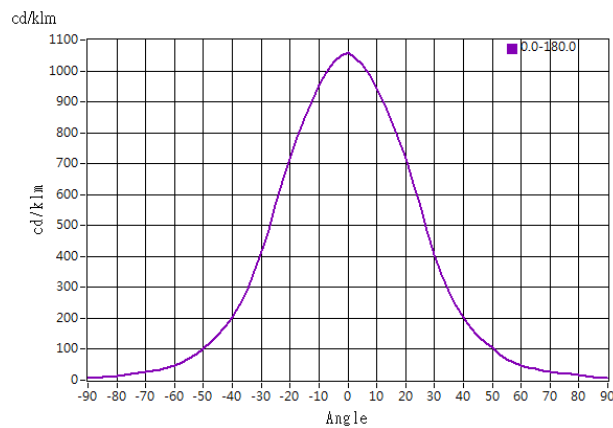

## Illuminance At Distances

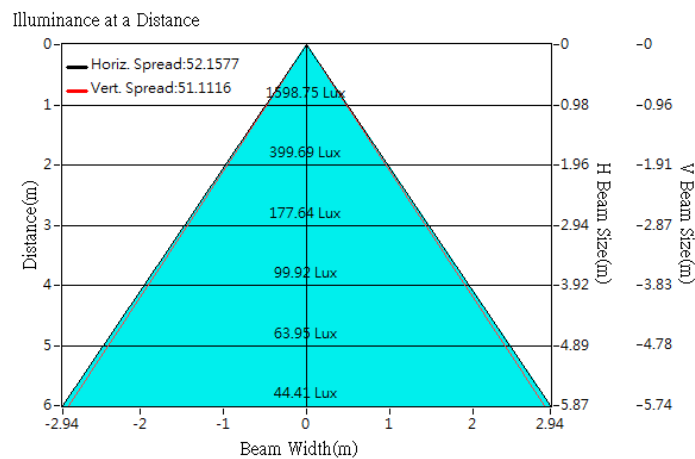



## Optical Characteristics

Model Number	CKO-CH15-060027-4350		<p>"H" definition</p>
LED	CLU 721		
LES / LED Size	Φ 11 mm		
FWHM (D50)	53°		
Field Angle (D10)	99°		
H (distance)	3.65mm		
Dimension	Φ =60 mm, Thickness=26.85 mm		
Luminous Flux	4008 lm	Measured @ 38.5 W	
Material	PC / UL94V2		

## cd/klm

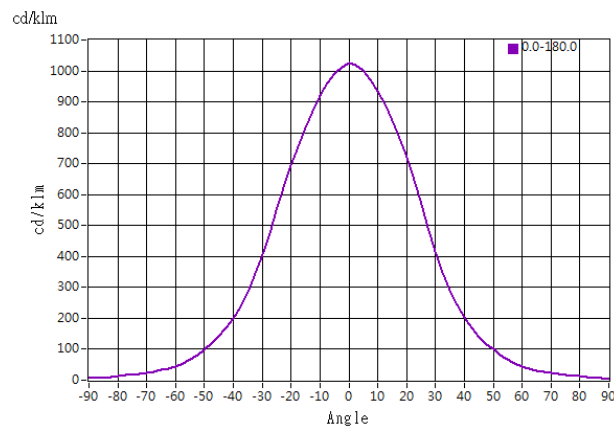

## Illuminance At Distances

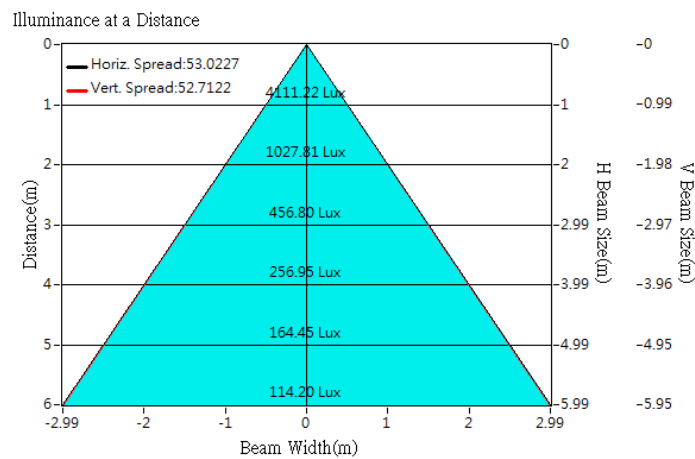



## Optical Characteristics

Model Number	CKO-CH15-060027-4350		<p>"H" definition</p>
LED	CLU 038		
LES / LED Size	Φ 14.5 mm		
FWHM (D50)	54°		
Field Angle (D10)	101°		
H (distance)	3.65mm		
Dimension	Φ =60 mm, Thickness=26.85 mm		
Luminous Flux	2649 lm	Measured @ 24.8 W	
Material	PC / UL94V2		

## cd/klm

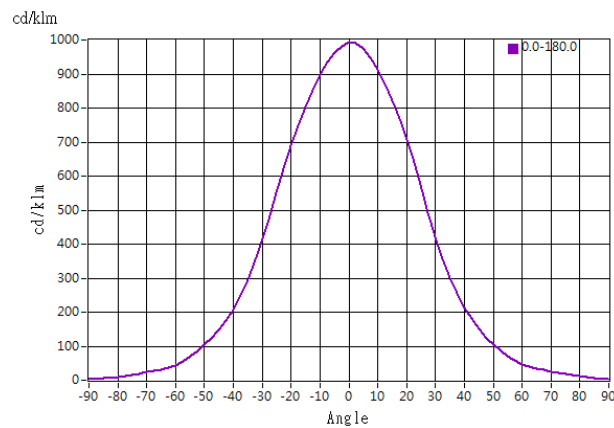

## Illuminance At Distances

