



Product Model Number

CKO-CH15-085040-5001

✓ Model Number Definitions

CKO-XXXX-XXXXXX-XXXX



- A. Chun Kuang Optics Corp. Product
- B. Product Type: product abbreviation
Ex:
CH→CoB High Intensity
CC→CoB Compact
CS→Soft Shading for CoB LED
HC→Holder for CoB LED

- C. Identity Code
- D. Lens / Fixture Size
Ex: 075026=Φ75mm / Thickness=26mm (round up)
- E. Serial Numbers

The lens datasheet is applicable for **Citizen LED**, that manufactured by Chun Kuang Optics Corp.

✓ Dimensions (mm) : Φ85 x 39.7

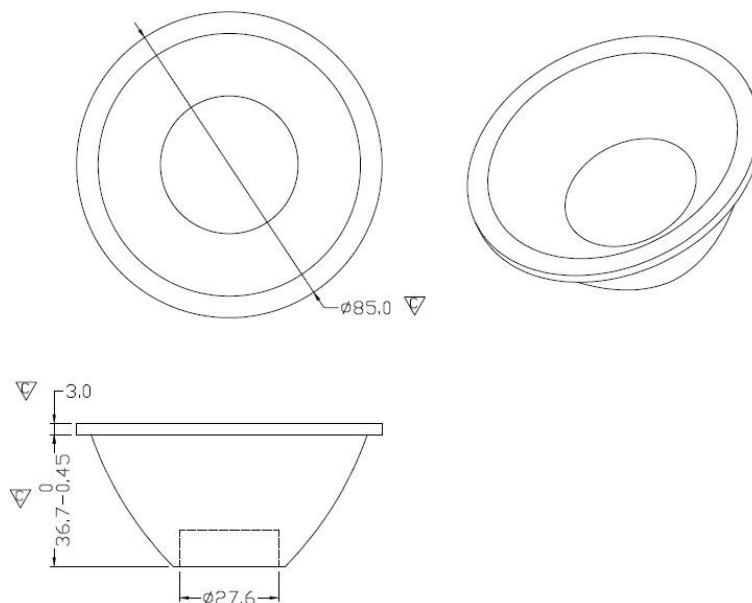

∇:Critical Dimension



Optical Characteristics

Model Number	CKO-CH15-085040-5001		<p>"H" definition</p> <p>LES CoB</p>
LED	CLU 024		
LES / LED Size	Φ 9.8 mm		
FWHM (D50)	11°		
Field Angle (D10)	23°		
H (distance)	3.65 mm		
Dimension	Φ =85 mm, Thickness=39.7 mm		
Luminous Flux	926 lm	Measured @ 9.5 W	
Material	PC / UL94V2		

cd/klm

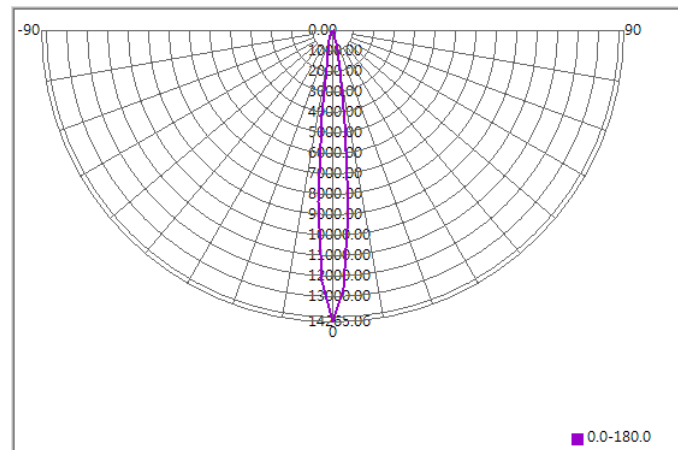

Illuminance At Distances

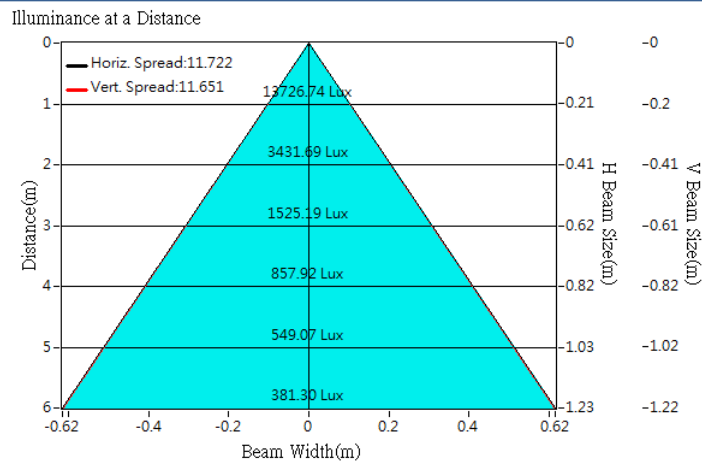



Optical Characteristics

Model Number	CKO-CH15-085040-5001	<p>"H" definition</p> <p>LES CoB</p>
LED	CLU 720	
LES / LED Size	Φ 11 mm	
FWHM (D50)	13°	
Field Angle (D10)	26°	
H (distance)	3.65 mm	
Dimension	Φ =85 mm, Thickness=39.7 mm	
Luminous Flux	3487 lm	
Material	PC / UL94V2	

cd/klm

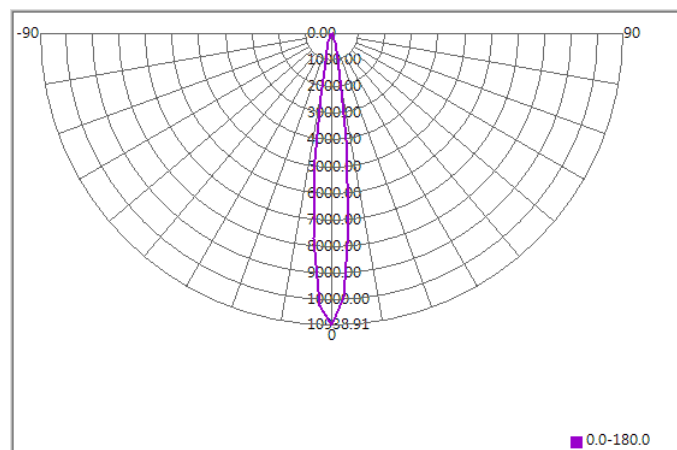

Illuminance At Distances

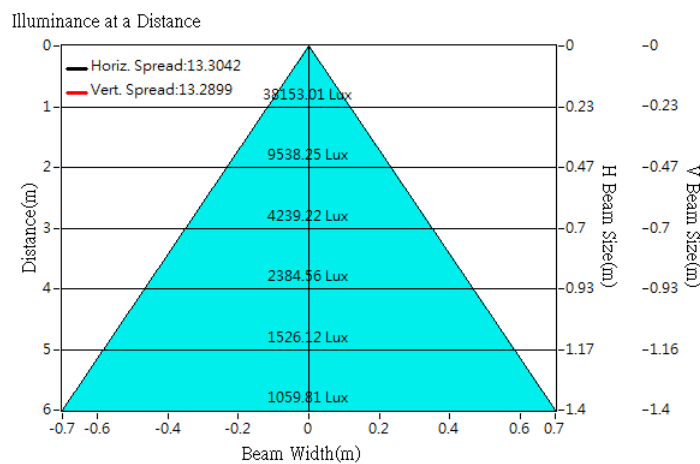



Optical Characteristics

Model Number	CKO-CH15-085040-5001		<p>"H" definition</p>
LED	CLU 730		
LES / LED Size	Φ 13 mm		
FWHM (D50)	16°		
Field Angle (D10)	31°		
H (distance)	3.65 mm		
Dimension	Φ =85 mm, Thickness=39.7 mm		
Luminous Flux	4909 lm	Measured @ 64.4 W	
Material	PC / UL94V2		

cd/klm

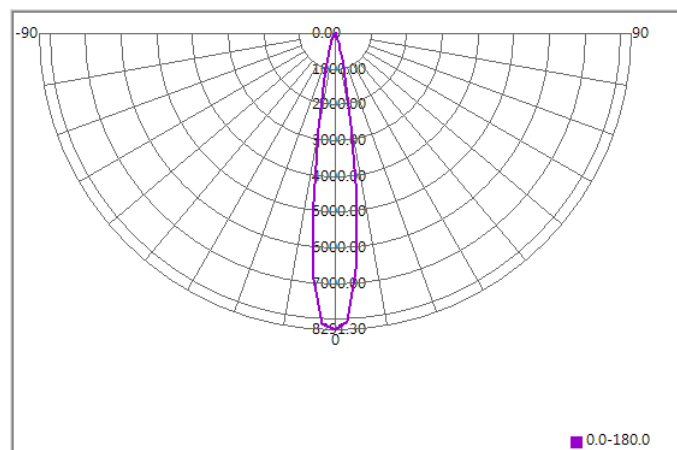

Illuminance At Distances

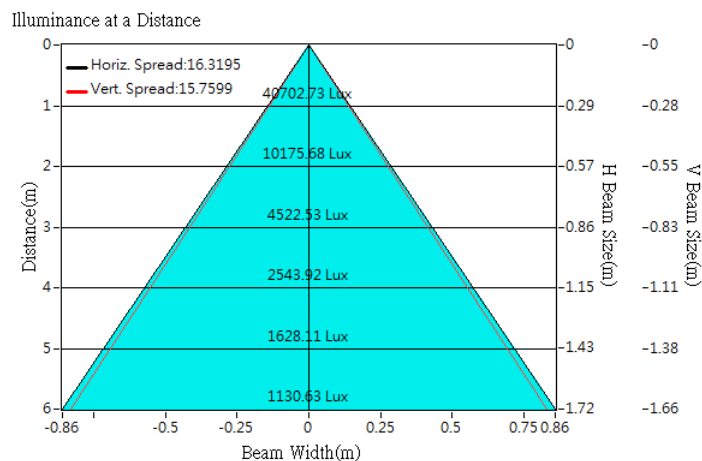



Optical Characteristics

Model Number	CKO-CH15-085040-5001		<p>"H" definition</p>
LED	CLU 038		
LES / LED Size	Φ 14.5 mm		
FWHM (D50)	16°		
Field Angle (D10)	32°		
H (distance)	3.65 mm		
Dimension	Φ =85 mm, Thickness=39.7 mm		
Luminous Flux	2801 lm	Measured @ 25.0 W	
Material	PC / UL94V2		

cd/klm

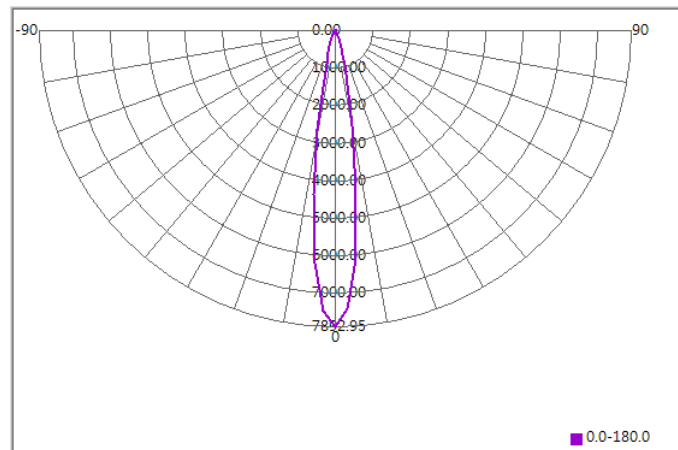

Illuminance At Distances

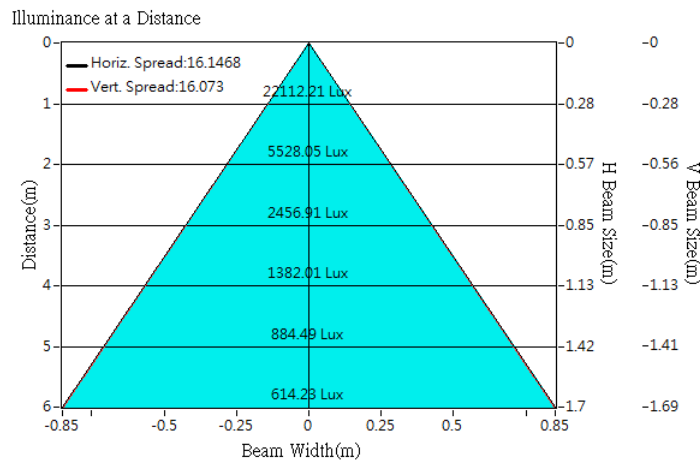



Optical Characteristics

Model Number	CKO-CH15-085040-5001		<p>"H" definition</p>
LED	CLU 036		
LES / LED Size	Φ 14.5 mm		
FWHM (D50)	18°		
Field Angle (D10)	35°		
H (distance)	3.65 mm		
Dimension	Φ =85 mm, Thickness=39.7 mm		
Luminous Flux	1956 lm	Measured @ 15.7 W	
Material	PC / UL94V2		

cd/klm

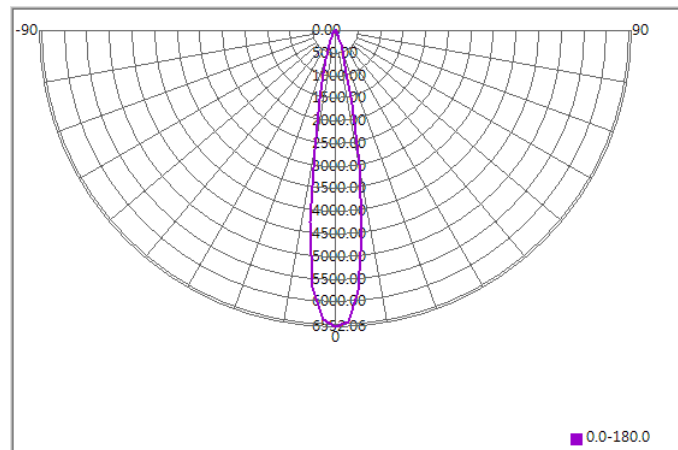

Illuminance At Distances

