



## Product Model Number

CKO-CH15-092043-2201

### ✓ Model Number Definitions

**CKO-XXXX-XXXXXX-XXXX**



- A. Chun Kuang Optics Corp. Product
- B. Product Type: product abbreviation  
Ex:  
CH→CoB High Intensity  
CC→CoB Compact  
CS→Soft Shading for CoB LED  
HC→Holder for CoB LED

- C. Identity Code
- D. Lens / Fixture Size  
Ex: 075026=Φ75mm / Thickness=26mm (round up)
- C. Serial Numbers

The lens datasheet is applicable for **Citizen LED**, that manufactured by Chun Kuang Optics Corp.

### ✓ Dimensions (mm) : Φ92 x 43

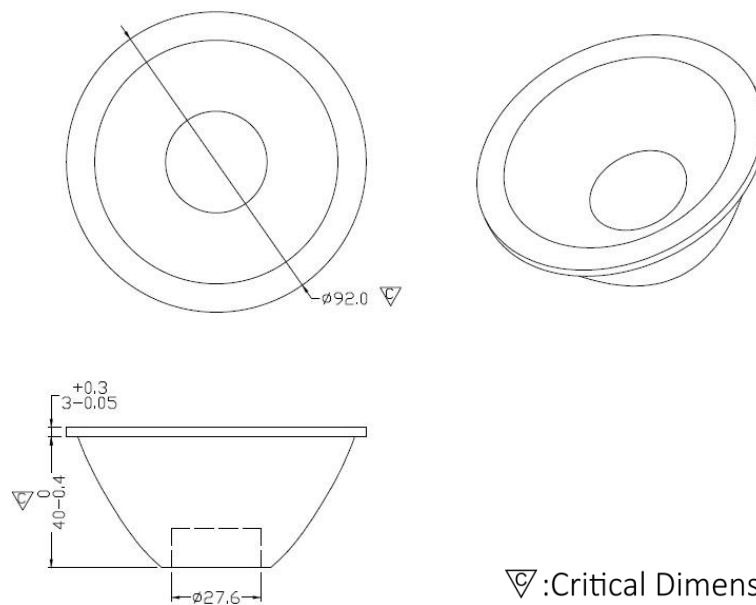

▽:Critical Dimension





## Optical Characteristics

Model Number	CKO-CH15-092043-2201		<p>"H" definition</p>
LED	CLU 720		
LES / LED Size	Φ 11 mm		
FWHM (D50)	13°		
Field Angle (D10)	29°		
H (distance)	3.65 mm		
Dimension	Φ =92 mm, Thickness=43 mm		
Luminous Flux	3335 lm	Measured @ 39.0 W	
Material	PC / UL94V2		

## cd/klm

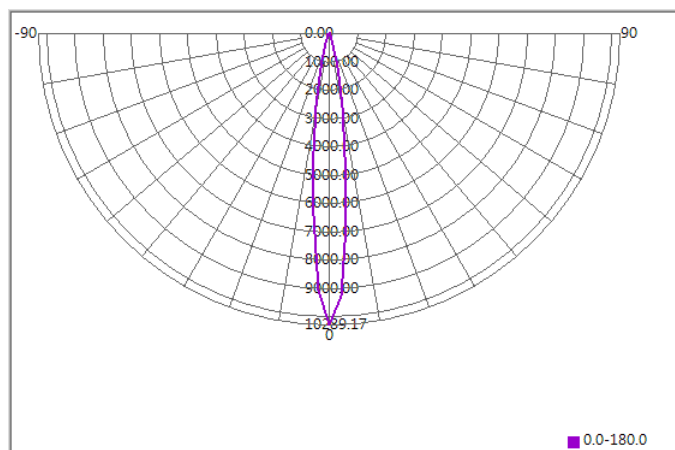

## Illuminance At Distances

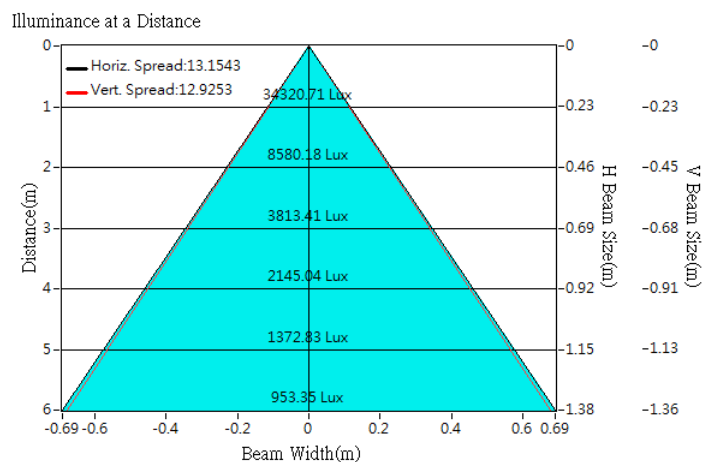





## Optical Characteristics

Model Number	CKO-CH15-092043-2201	<p>"H" definition</p>
LED	<b>CLU 730</b>	
LES / LED Size	Φ 13 mm	
FWHM (D50)	14°	
Field Angle (D10)	32°	
H (distance)	3.65 mm	
Dimension	Φ =92 mm, Thickness=43 mm	
Luminous Flux	4623 lm	
Material	PC / UL94V2	

## cd/klm

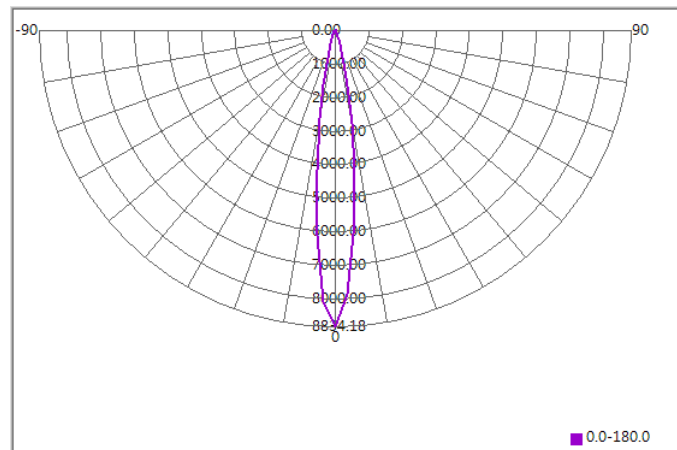

## Illuminance At Distances

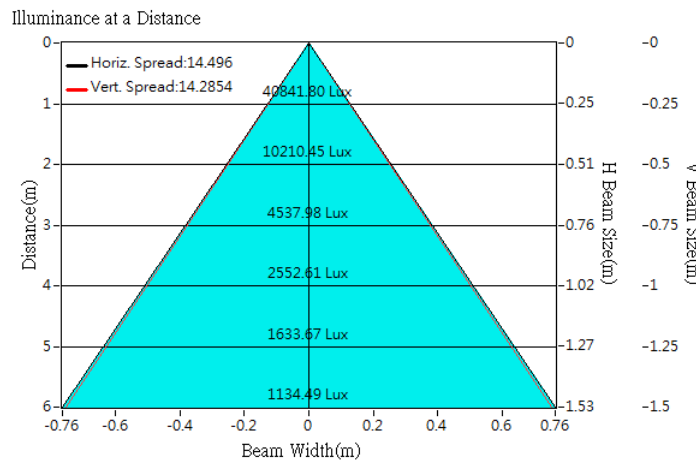



## Optical Characteristics

Model Number	CKO-CH15-092043-2201		<p>"H" definition</p>
LED	CLU 038		
LES / LED Size	Φ 14.5 mm		
FWHM (D50)	14°		
Field Angle (D10)	34°		
H (distance)	3.65 mm		
Dimension	Φ =92 mm, Thickness=43 mm		
Luminous Flux	2667 lm	Measured @25W	
Material	PC / UL94V2		

## cd/klm

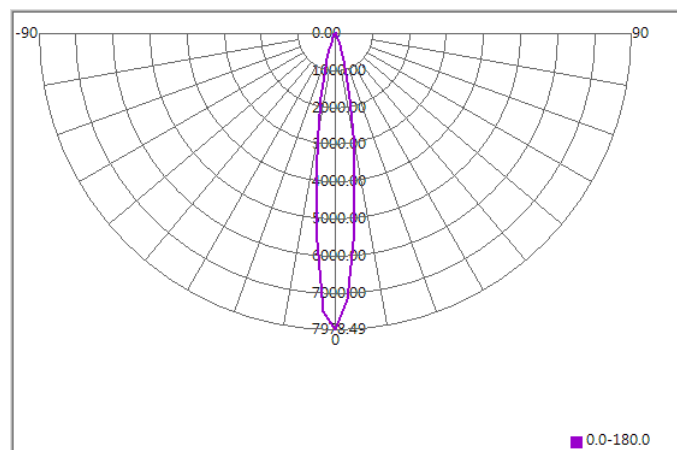

## Illuminance At Distances

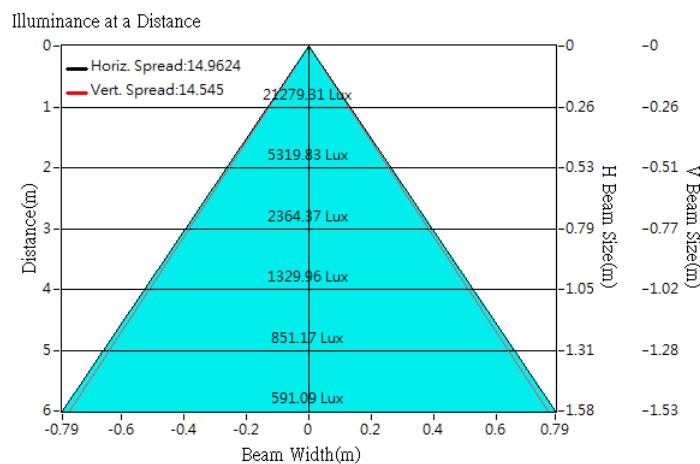



## Lens Accessories - CoB Holder

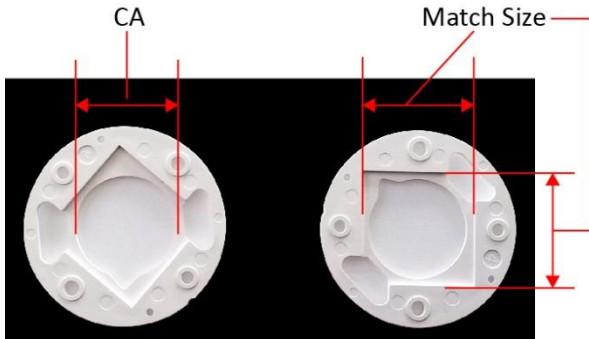

Example of LES Area & LED Size Dimension Locations

Product Model	Match Size (mm)	CA (mm)	Material	Applicability
CKO-HC13-131311-6416	13.8 x 13.8	Φ 11.6	PBT	<b>Citizen CLL020</b>
CKO-HC13-191917-6417	19.3 x 19.3	Φ 17.4	PBT	<b>Citizen CLL030</b>
CKO-HC13-282824-6418	28.3 x 28.3	Φ 24.9	PBT	<b>Citizen CLL040</b>