



## Product Model Number

CKO-CH15-092043-2501

### ✓ Model Number Definitions

**CKO-XXXX-XXXXXX-XXXX**



- A. Chun Kuang Optics Corp. Product
- B. Product Type: product abbreviation  
Ex:  
CH→CoB High Intensity  
CC→CoB Compact  
CS→Soft Shading for CoB LED  
HC→Holder for CoB LED

- C. Identity Code
- D. Lens / Fixture Size  
Ex: 075026=Φ75mm / Thickness=26mm (round up)
- C. Serial Numbers

The lens datasheet is applicable for **Philips LED**, that manufactured by Chun Kuang Optics Corp.

### ✓ Dimensions (mm) : Φ92 x 43

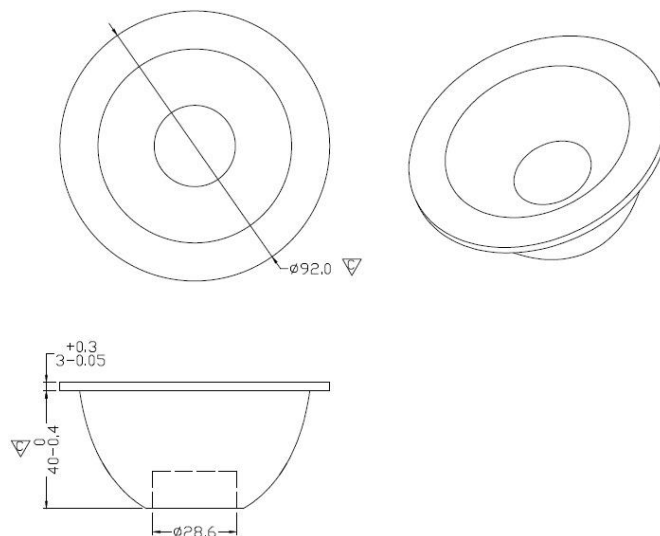

▽:Critical Dimension





## Optical Characteristics

Model Number	CKO-CH15-092043-2501		<p>"H" definition</p>
LED	Fortimo SLM 1205 L13 G7		
LES / LED Size	Φ 13 mm		
FWHM (D50)	36°		
Field Angle (D10)	64°		
H (distance)	3.65 mm		
Dimension	Φ =92 mm, Thickness=43 mm		
Luminous Flux	1804 lm	Measured @ 17.5 W	
Material	PC / UL94V2		

## cd/klm

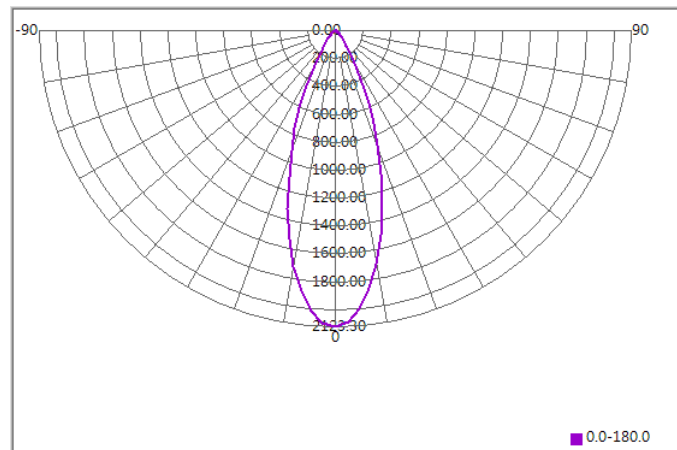

## Illuminance At Distances

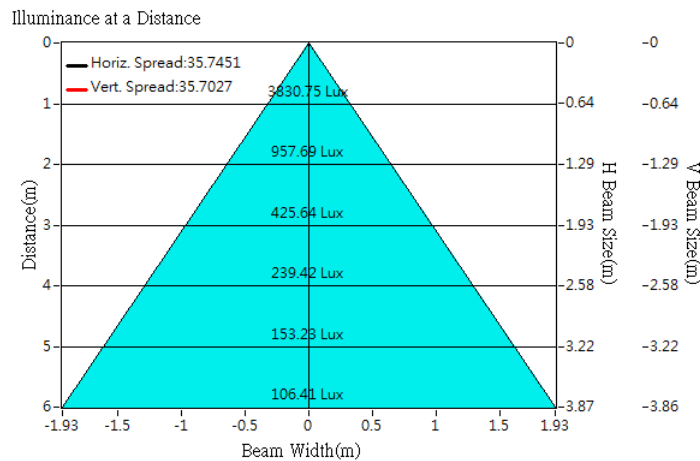





## Optical Characteristics

Model Number	CKO-CH15-092043-2501		<p>"H" definition</p>
LED	Fortimo SLM C 1205 L13 2024 G6_DL		
LES / LED Size	Φ 13 mm		
FWHM (D50)	39°		
Field Angle (D10)	65°		
H (distance)	3.5mm		
Dimension	Φ =92 mm, Thickness=43 mm		
Luminous Flux	2059 lm	Measured @ 17.6 W	
Material	PC / UL94V2		

## cd/klm

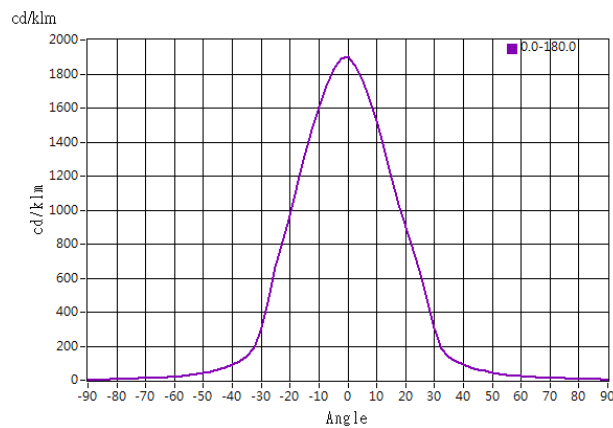

## Illuminance At Distances

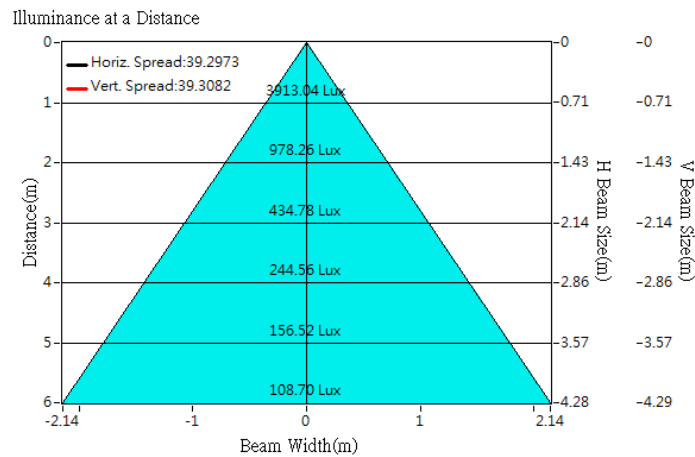



## Optical Characteristics

Model Number	CKO-CH15-092043-2501		
LED	Fortimo SLM C 1205 L13 2024 G6_PI		
LES / LED Size	Φ 13 mm		
FWHM (D50)	39°		
Field Angle (D10)	65°		
H (distance)	3.5mm		
Dimension	Φ =92 mm, Thickness=43 mm		
Luminous Flux	2059 lm	Measured @ 17.6 W	
Material	PC / UL94V2		

## cd/klm

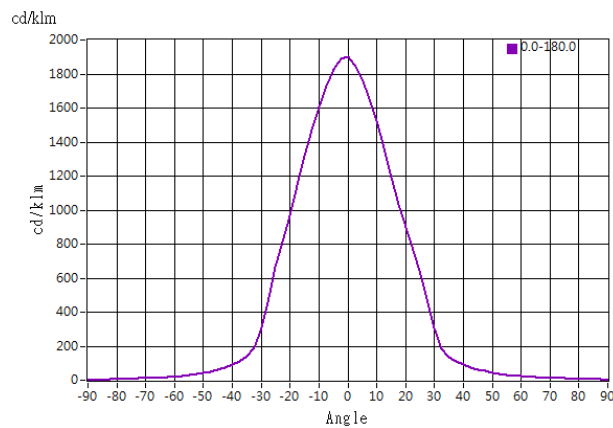

## Illuminance At Distances

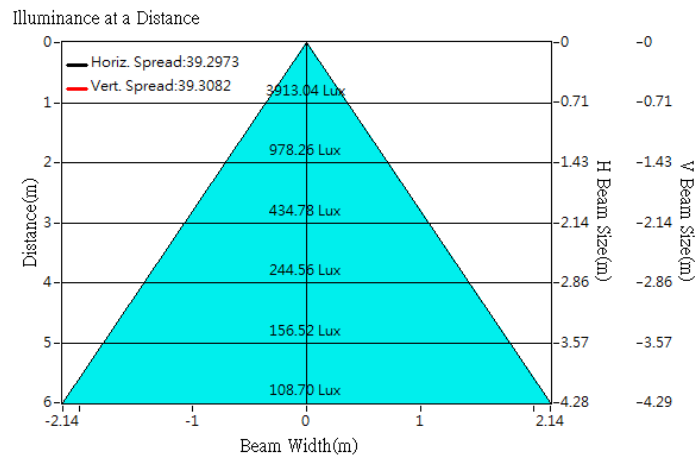



## Optical Characteristics

Model Number	CKO-CH15-092043-2401		<p>"H" definition</p>
LED	<b>Fortimo SLM 1205 L15 G7N</b>		
LES / LED Size	Φ 14.5 mm		
FWHM (D50)	36°		
Field Angle (D10)	64°		
H (distance)	3.65 mm		
Dimension	Φ =92 mm, Thickness=43 mm		
Luminous Flux	2075 lm	Measured @ 15.4 W	
Material	PC / UL94V2		

## cd/klm

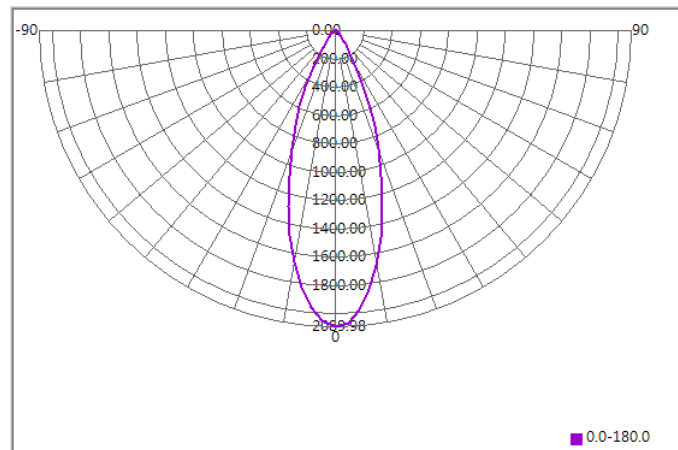

## Illuminance At Distances

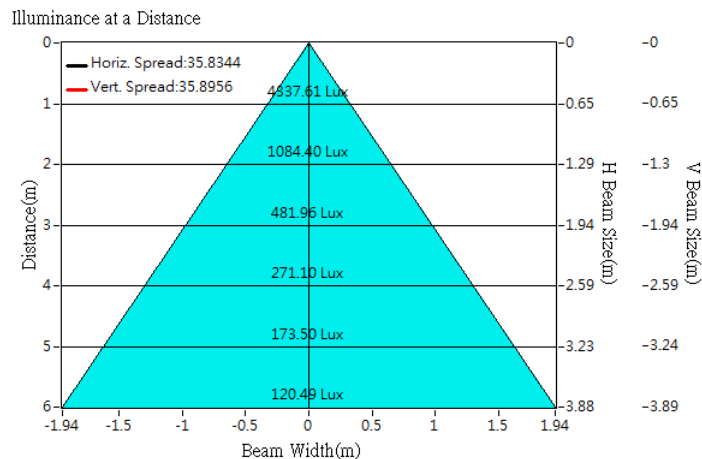





## Optical Characteristics

Model Number	CKO-CH15-092043-2401		<p>"H" definition</p> <p>LES CoB</p>
LED	<b>Fortimo SLM 1206 L15 G7N</b>		
LES / LED Size	Φ 14.5 mm		
FWHM (D50)	36°		
Field Angle (D10)	65°		
H (distance)	3.65 mm		
Dimension	Φ =92 mm, Thickness=43 mm		
Luminous Flux	2542 lm	Measured @ 18.5 W	
Material	PC / UL94V2		

## cd/klm

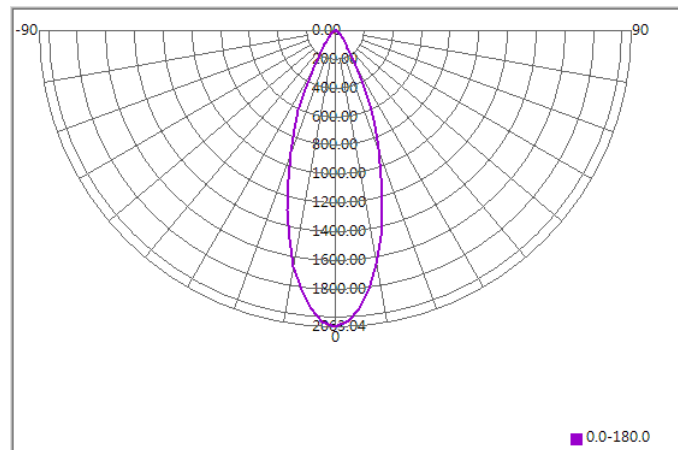

## Illuminance At Distances

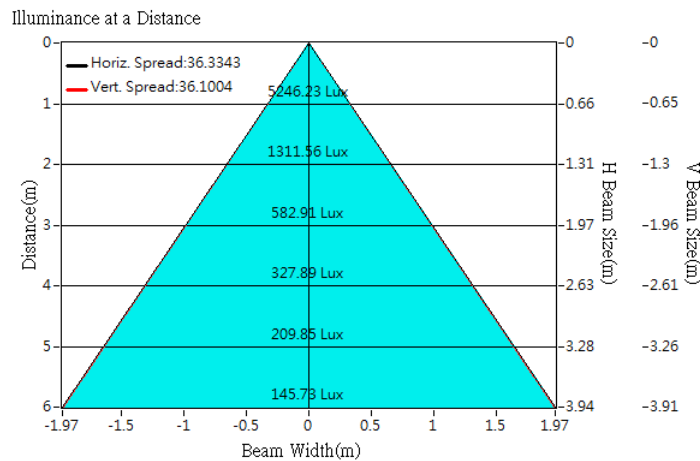



## Optical Characteristics

Model Number	CKO-CH15-092043-2401		<p>"H" definition</p> <p>LES CoB</p>
LED	Fortimo SLM 1208 L15 G7N		
LES / LED Size	Φ 14.5 mm		
FWHM (D50)	37°		
Field Angle (D10)	65°		
H (distance)	3.65 mm		
Dimension	Φ =92 mm, Thickness=43 mm		
Luminous Flux	3497 lm	Measured @ 25.0 W	
Material	PC / UL94V2		

## cd/klm

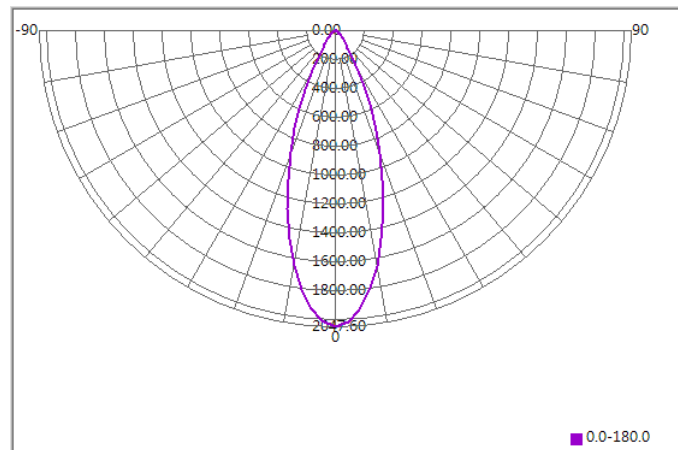

## Illuminance At Distances

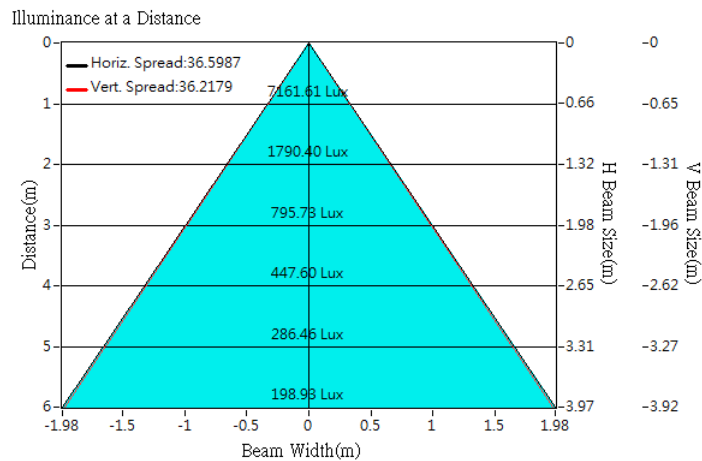





## Optical Characteristics

Model Number	CKO-CH15-092043-2501		<p>"H" definition</p>
LED	Fortimo SLM 1208 L15 G7_DL		
LES / LED Size	Φ 15 mm		
FWHM (D50)	36°		
Field Angle (D10)	65°		
H (distance)	3.5 mm		
Dimension	Φ =92 mm, Thickness=43 mm		
Luminous Flux	2823 lm	Measured @ 26.5 W	
Material	PC / UL94V2		

## cd/klm

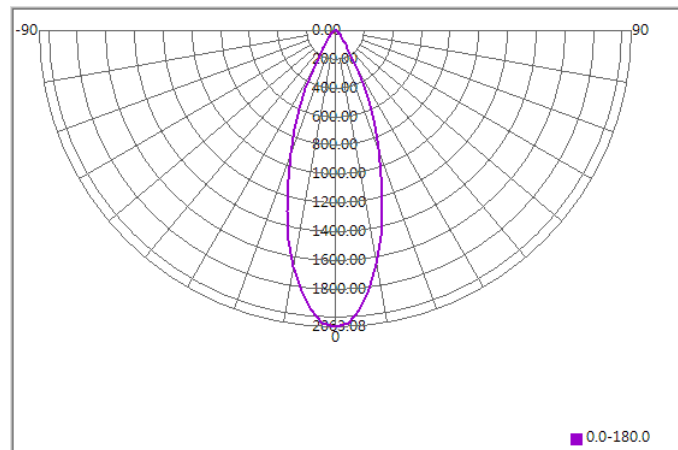

## Illuminance At Distances

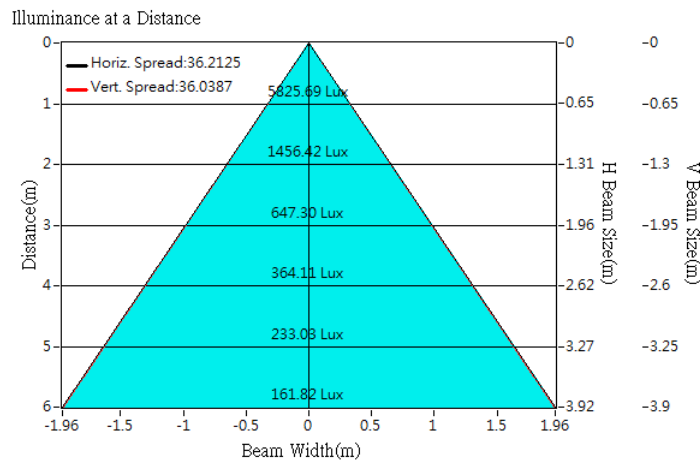



## Optical Characteristics

Model Number	CKO-CH15-092043-2501		
LED	Fortimo SLM C 1208 L15 2024 G6_DL		
LES / LED Size	Φ 15 mm		
FWHM (D50)	40°		
Field Angle (D10)	66°		
H (distance)	3.5mm		
Dimension	Φ =92 mm, Thickness=43 mm		
Luminous Flux	2531 lm	Measured @ 26.9 W	
Material	PC / UL94V2		

## cd/klm

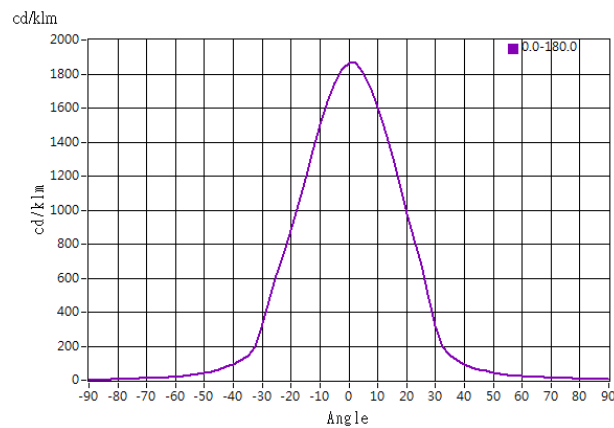

## Illuminance At Distances

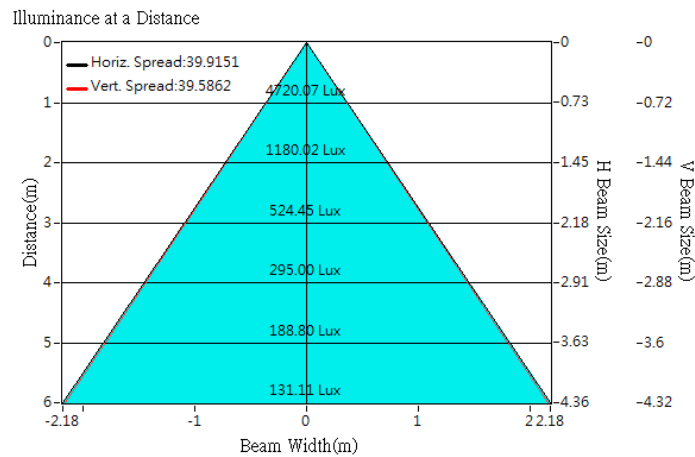



## Optical Characteristics

Model Number	CKO-CH15-092043-2501		
LED	Fortimo SLM C 1208 L15 2024 G6_PI		
LES / LED Size	Φ 15 mm		
FWHM (D50)	40°		
Field Angle (D10)	66°		
H (distance)	3.5mm		
Dimension	Φ =92 mm, Thickness=43 mm		
Luminous Flux	2531 lm	Measured @ 26.9 W	
Material	PC / UL94V2		

## cd/klm

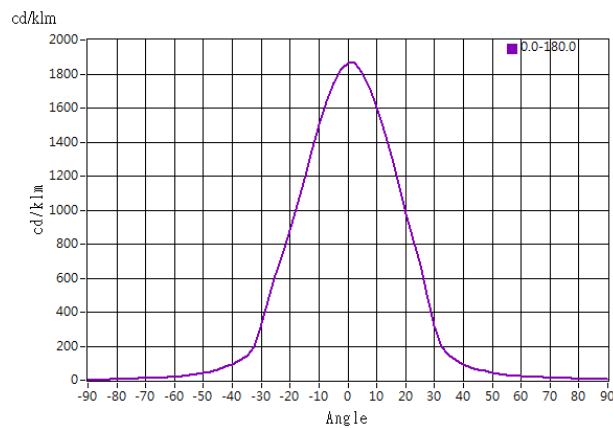

## Illuminance At Distances

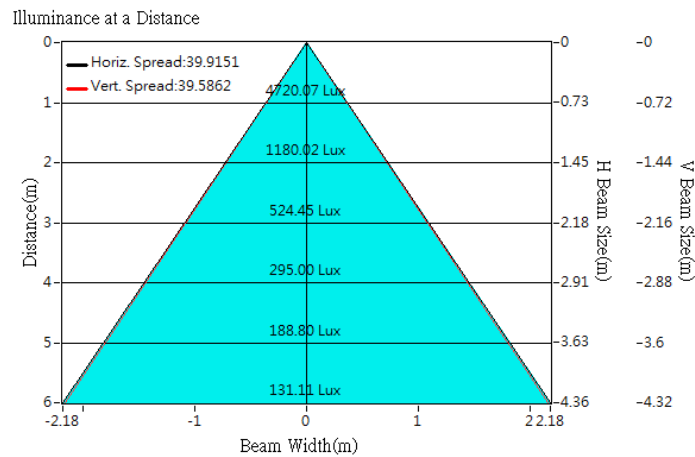





## Optical Characteristics

Model Number	CKO-CH15-092043-2401		<p>"H" definition</p>
LED	<b>Fortimo SLM 1211 L22 G7N</b>		
LES / LED Size	Φ 22 mm		
FWHM (D50)	43°		
Field Angle (D10)	74°		
H (distance)	3.65 mm		
Dimension	Φ =92 mm, Thickness=43 mm		
Luminous Flux	3991 lm	Measured @ 34.1 W	
Material	PC / UL94V2		

## cd/klm

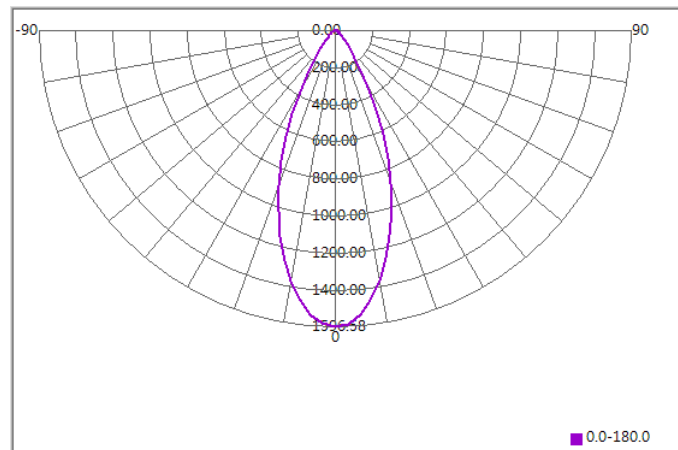

## Illuminance At Distances

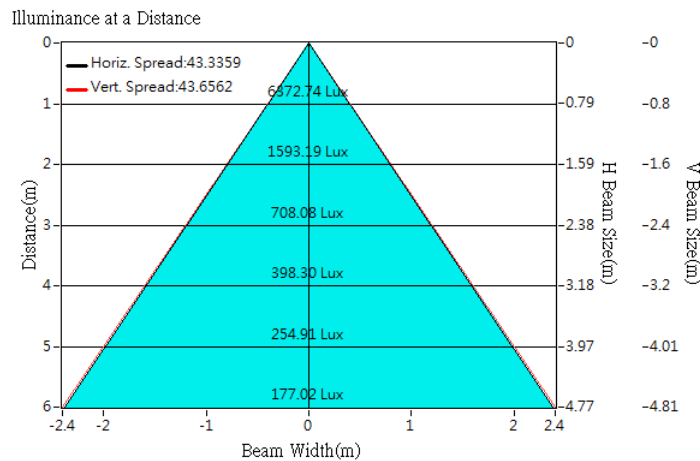



## Lens Accessories - CoB Holder

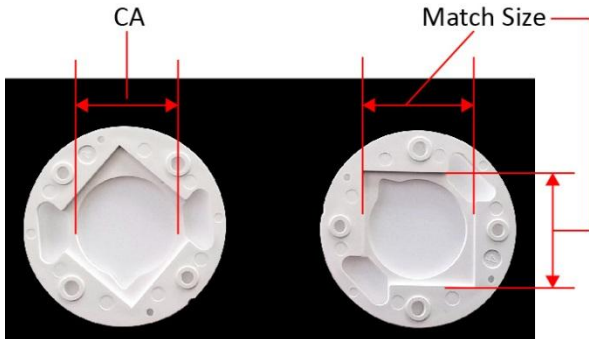

Example of LES Area & LED Size Dimension Locations

Product Model	Match Size (mm)	CA (mm)	Material	Applicability
CKO-HC14-161911-0501	16.3 x 19.3	Φ 11.9	PBT	<b>Philips 1202</b>
CKO-HC14-161911-0501	16.3 x 19.3	Φ 11.9	PBT	<b>Philips 1203</b>
CKO-HC14-202419-0502	20.3 x 24.3	Φ 19.2	PBT	<b>Philips 1204</b>
CKO-HC14-202419-0502	20.3 x 24.3	Φ 19.2	PBT	<b>Philips 1205</b>