



## Product Model Number

CKO-CH19-035018-2860

### ✓ Model Number Definitions

**CKO-XXXX-XXXXXX-XXXX**



- A. Chun Kuang Optics Corp. Product
- B. Product Type: product abbreviation  
Ex:  
CH→CoB High Intensity  
CC→CoB Compact  
CS→Soft Shading for CoB LED  
HC→Holder for CoB LED

- C. Identity Code
- D. Lens / Fixture Size  
Ex: 075026=Φ75mm / Thickness=26mm (round up)
- E. Serial Numbers



The lens datasheet is applicable for **Luminus LED**, that manufactured by Chun Kuang Optics Corp.

### ✓ Dimensions (mm) : Φ35 x 17.4



▽:Critical Dimension



✓ Optical Characteristics – Angle Performances

Luminus	LED LES (mm)	FWHM (degrees)	Field Angle (degrees)
CXM-3-AC40	Φ3.5	58°	82°
CXM-4-AC40	Φ4.5	56°	81°
CXM-9-AC30	Φ9.6	54°	85°
CXM-9-AC40	Φ9.8	56°	85°



## Optical Characteristics

Model Number	CKO-CH19-035018-2860		<p>"H" definition</p> <p>LES CoB</p>
LED	CXM-3-AC40		
LES / LED Size	Φ 3.5 mm		
FWHM (D50)	58°		
Field Angle (D10)	82°		
H (distance)	2.5 mm		
Dimension	Φ =35mm, Thickness=17.4mm		
Luminous Flux	298 lm	Measured @ 2.8 W	
Material	PC / UL94V2		

## cd/klm

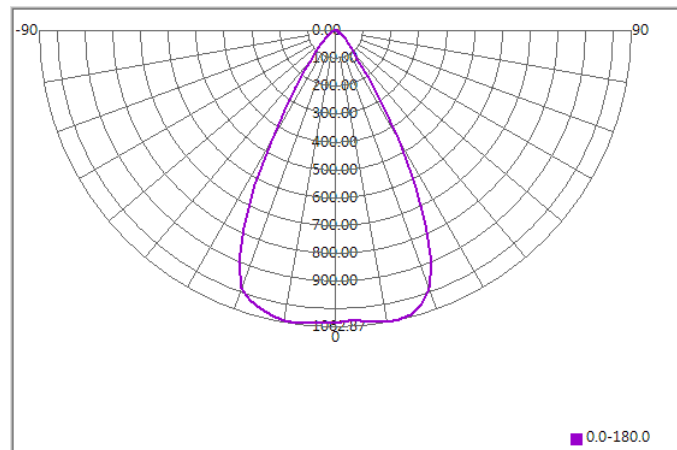

## Illuminance At Distances

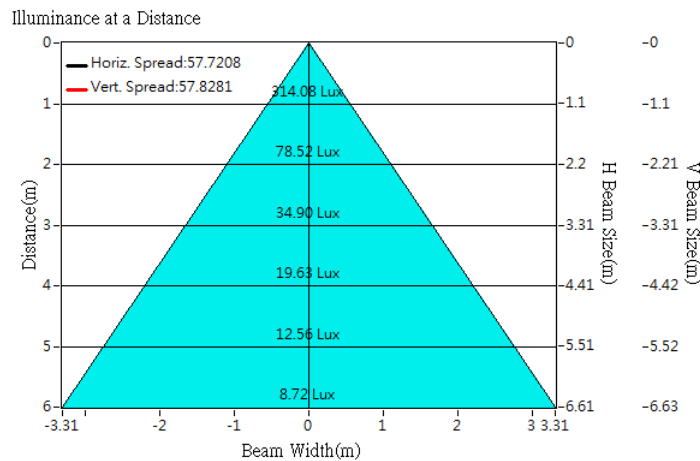

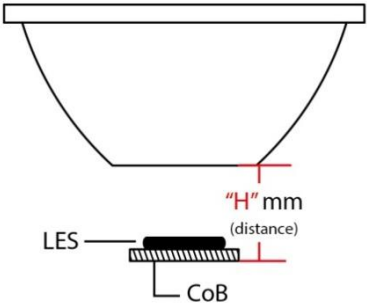

## Optical Characteristics

Model Number	CKO-CH19-035018-2860	<p>"H" definition</p> 
LED	<b>CXM-4-AC40</b>	
LES / LED Size	Φ 4.5 mm	
FWHM (D50)	56°	
Field Angle (D10)	81°	
H (distance)	2.5 mm	
Dimension	Φ =35mm, Thickness=17.4mm	
Luminous Flux	459 lm      Measured @ 4 W	
Material	PC / UL94V2	

## cd/klm

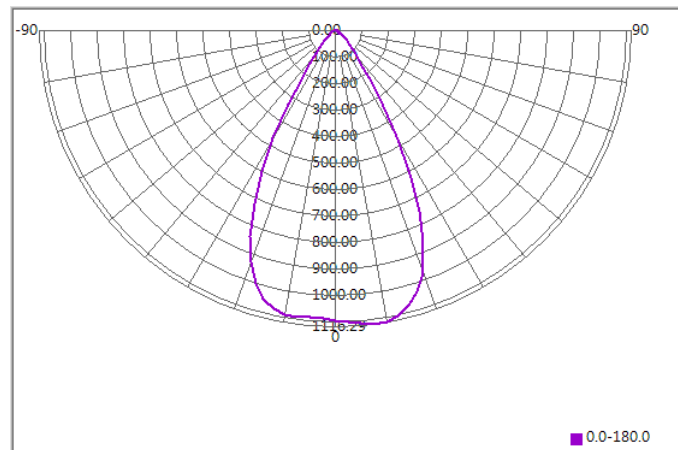

## Illuminance At Distances

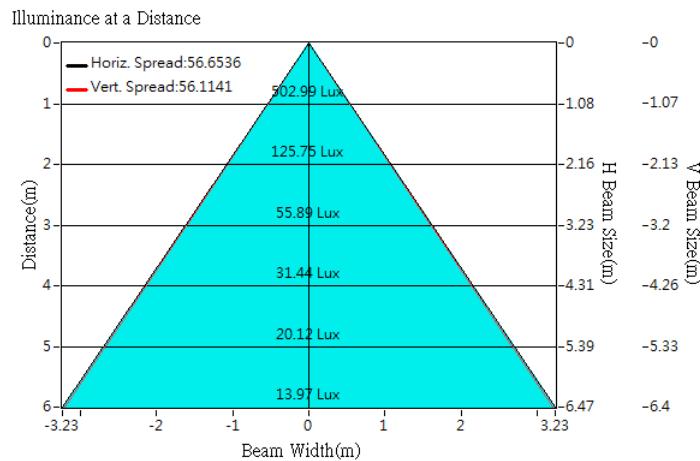



## Optical Characteristics

Model Number	CKO-CH19-035018-2860		<p>"H" definition</p> <p>LES CoB</p>
LED	CXM-9-AC30		
LES / LED Size	Φ 9.6 mm		
FWHM (D50)	54°		
Field Angle (D10)	85°		
H (distance)	2.5 mm		
Dimension	Φ =35mm, Thickness=17.4mm		
Luminous Flux	1305 lm	Measured @ 12.1 W	
Material	PC / UL94V2		

## cd/klm

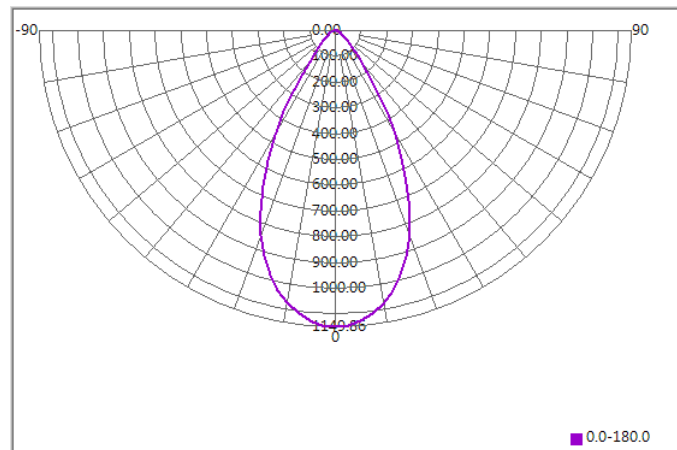

## Illuminance At Distances

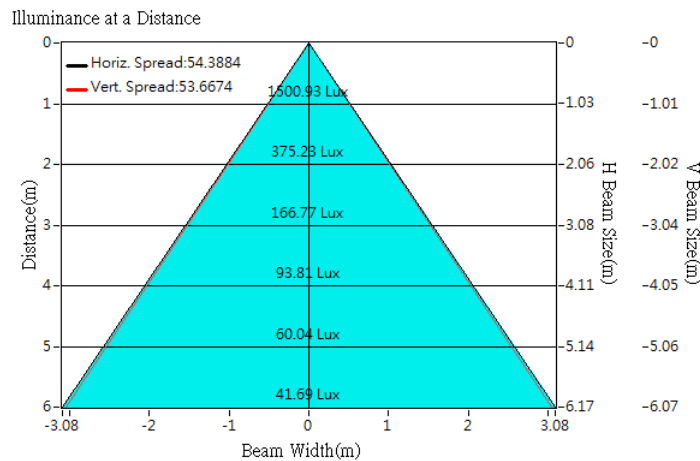



## Optical Characteristics

Model Number	CKO-CH19-035018-2860	<p>"H" definition</p>
LED	<b>CXM-9-AC40</b>	
LES / LED Size	Φ 9.8 mm	
FWHM (D50)	56°	
Field Angle (D10)	85°	
H (distance)	2.5 mm	
Dimension	Φ =35mm, Thickness=17.4mm	
Luminous Flux	1388 lm	
Material	PC / UL94V2	

## cd/klm

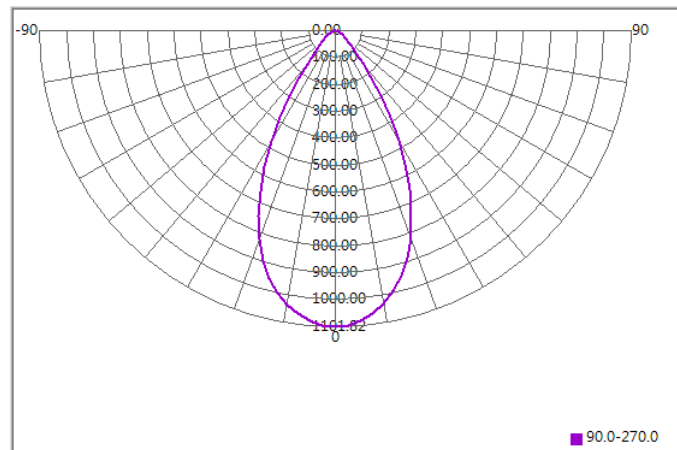

## Illuminance At Distances

