



Product Model Number

CKO-CS15-075033-4001

✓ Model Number Definitions

CKO-XXXX-XXXXXX-XXXX



- A. Chun Kuang Optics Corp. Product
- B. Product Type: product abbreviation
Ex:
CH→CoB High Intensity
CC→CoB Compact
CS→Soft Shading for CoB LED
HC→Holder for CoB LED

- C. Identity Code
- D. Lens / Fixture Size
Ex: 075026=Φ75mm / Thickness=26mm (round up)
- C. Serial Numbers

The lens datasheet is applicable for **TRIDONIC LED**, that manufactured by Chun Kuang Optics Corp.

✓ Dimensions (mm) : Φ75 x 33

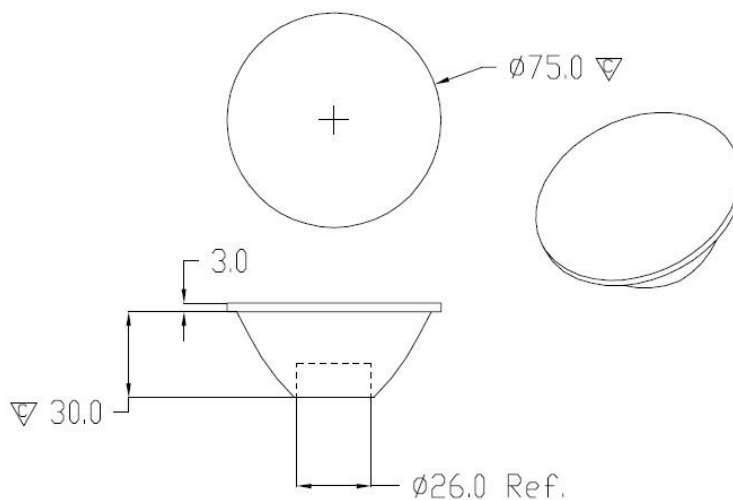

∇ :Critical Dimension



Optical Characteristics

Model Number	CKO-CS15-075033-4001		
LED	SLE G7 13mm 3000lm 930 R ADV		
LES / LED Size	Φ 13 mm		
FWHM (D50)	17°		
Field Angle (D10)	34°		
H (distance)	3.65 mm		
Dimension	Φ =75 mm, Thickness= 33 mm		
Luminous Flux	1925 lm	Measured @ 18 W	
Material	PC / UL94V2		

cd/klm

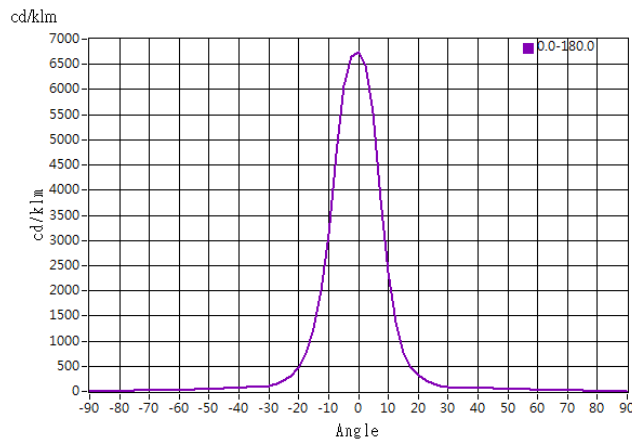

Illuminance At Distances

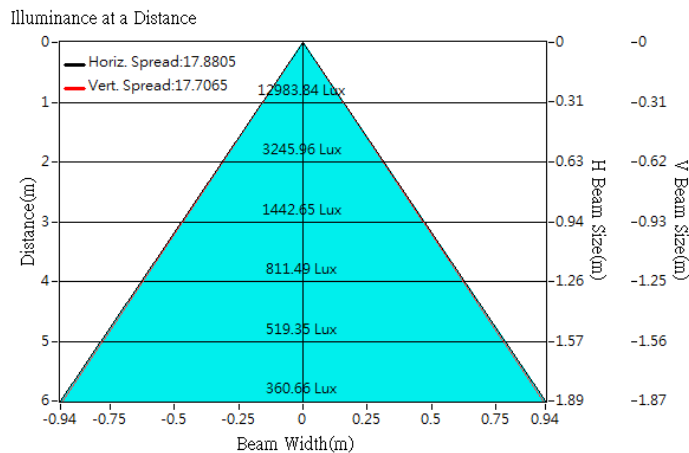



Optical Characteristics

Model Number	CKO-CS15-075033-4001		
LED	SLE G7 15mm 4000lm 840 R ADV		
LES / LED Size	Φ 15 mm		
FWHM (D50)	20°		
Field Angle (D10)	38°		
H (distance)	3.65 mm		
Dimension	Φ =75 mm, Thickness= 33 mm		
Luminous Flux	4125 lm	Measured @ 33.4 W	
Material	PC / UL94V2		

cd/klm

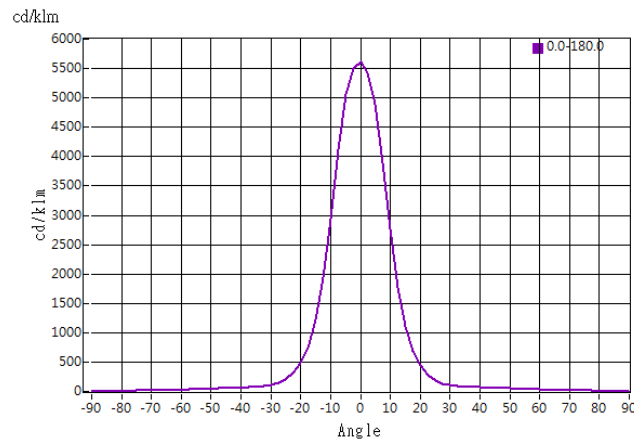

Illuminance At Distances

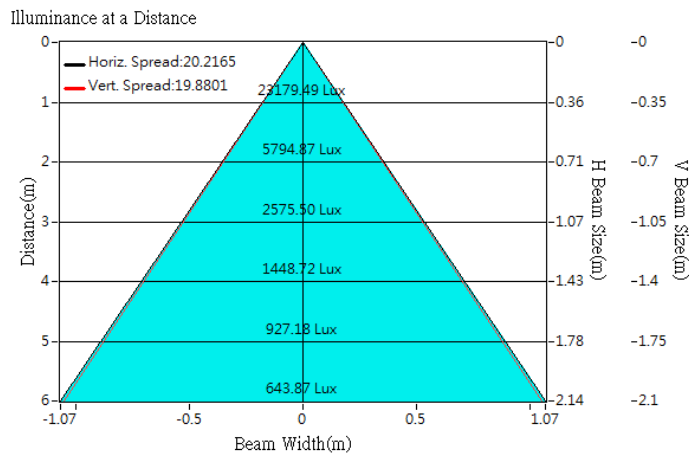



Optical Characteristics

Model Number	CKO-CS15-075033-4001		
LED	SLE G7 17mm 5000lm 830 R ADV		
LES / LED Size	Φ 17 mm		
FWHM (D50)	23°		
Field Angle (D10)	42°		
H (distance)	3.65 mm		
Dimension	Φ =75 mm, Thickness= 33 mm		
Luminous Flux	4637 lm	Measured @ 38.2 W	
Material	PC / UL94V2		

cd/klm

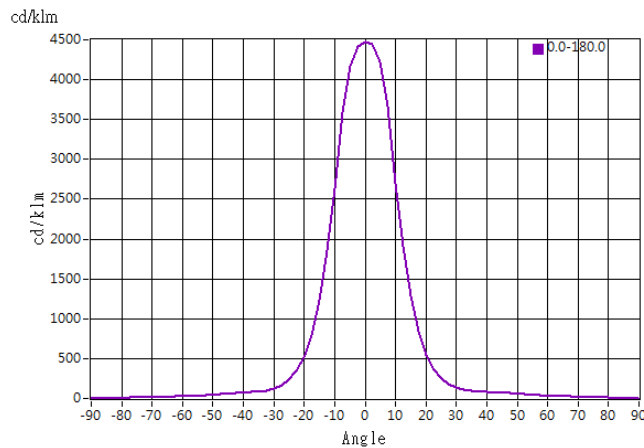

Illuminance At Distances

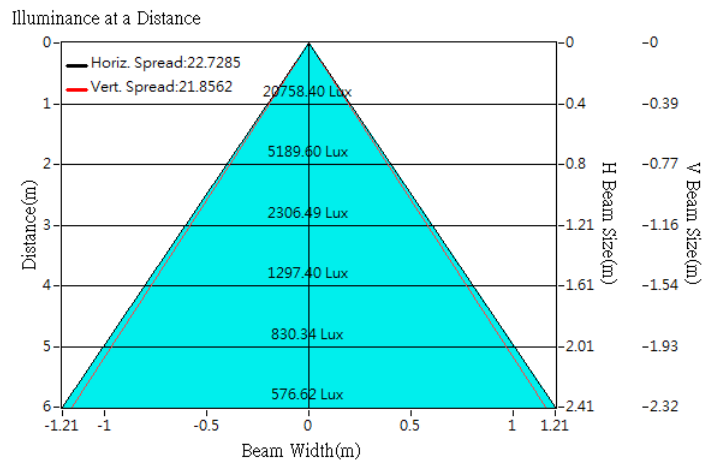



Optical Characteristics

Model Number	CKO-CS15-075033-4001		<p>"H" definition</p> <p>LES</p> <p>CoB</p>
LED	SLE G7 21mm 6000lm 840 R ADV		
LES / LED Size	Φ 21 mm		
FWHM (D50)	28°		
Field Angle (D10)	52°		
H (distance)	3.65 mm		
Dimension	Φ =75 mm, Thickness= 33 mm		
Luminous Flux	6394 lm	Measured @ 50.9 W	
Material	PC / UL94V2		

cd/klm

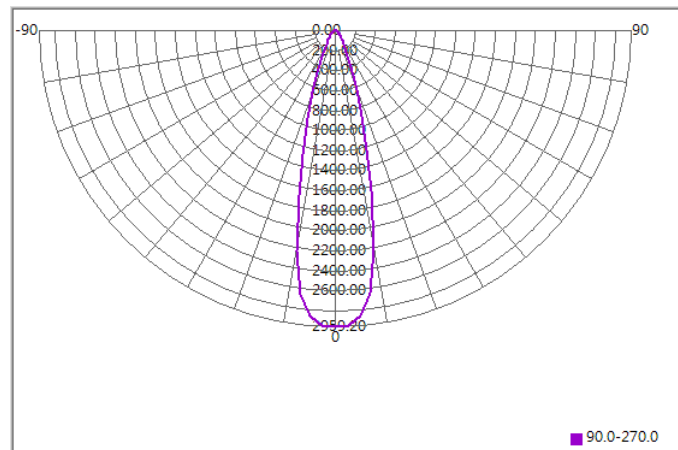

Illuminance At Distances

