



Product Model Number

CKO-CS15-075033-4005

✓ Model Number Definitions

CKO-XXXX-XXXXXX-XXXX

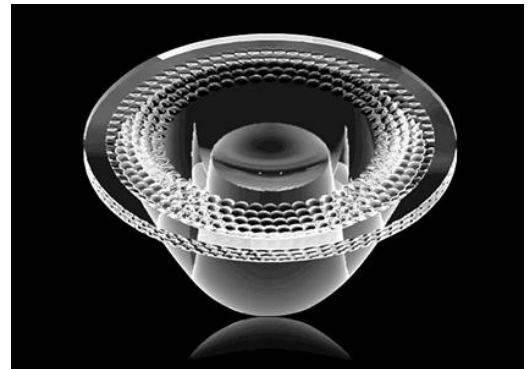

- A. Chun Kuang Optics Corp. Product
- B. Product Type: product abbreviation
Ex:
CH→CoB High Intensity
CC→CoB Compact
CS→Soft Shading for CoB LED
HC→Holder for CoB LED

- C. Identity Code
- D. Lens / Fixture Size
Ex: 075026=Φ75mm / Thickness=26mm (round up)
- C. Serial Numbers

The lens datasheet is applicable for **Lumileds LED**, that manufactured by Chun Kuang Optics Corp.

✓ Dimensions (mm) : Φ75 x 33

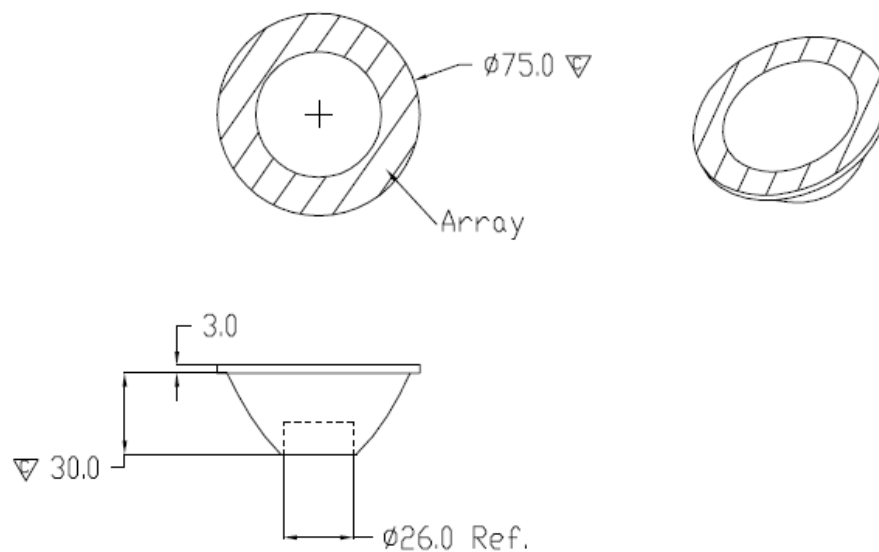

▽:Critical Dimension



Optical Characteristics

Model Number	CKO-CS15-075033-4005		<p>"H" definition</p>
LED	LUXEON 1204		
LES / LED Size	Φ 13 mm		
FWHM (D50)	30°		
Field Angle (D10)	50°		
H (distance)	3.65 mm		
Dimension	Φ =75 mm, Thickness= 33 mm		
Luminous Flux	1453 lm	Measured @ 16.5 W	
Material	PC / UL94V2		

cd/klm

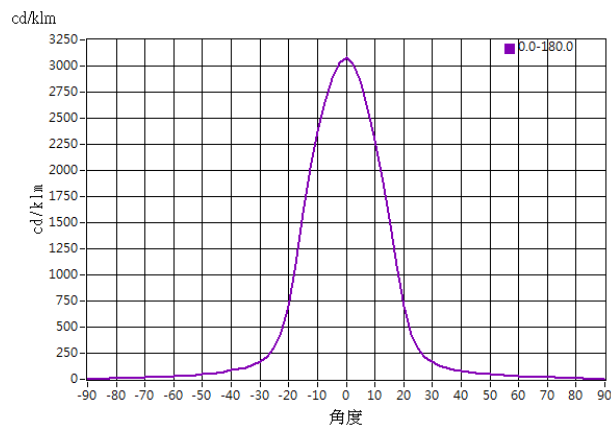

Illuminance At Distances

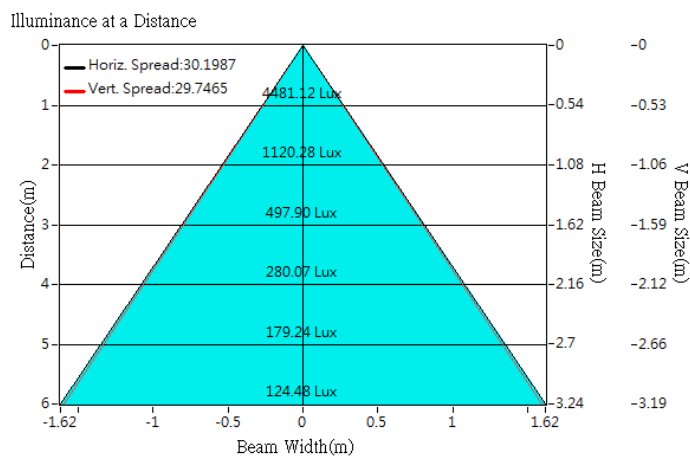



Optical Characteristics

Model Number	CKO-CS15-075033-4005		<p>"H" definition</p>
LED	LUXEON 1205		
LES / LED Size	Φ 13 mm		
FWHM (D50)	29°		
Field Angle (D10)	48°		
H (distance)	3.65 mm		
Dimension	Φ =75 mm, Thickness= 33 mm		
Luminous Flux	2025 lm	Measured @ 22.1 W	
Material	PC / UL94V2		

cd/klm

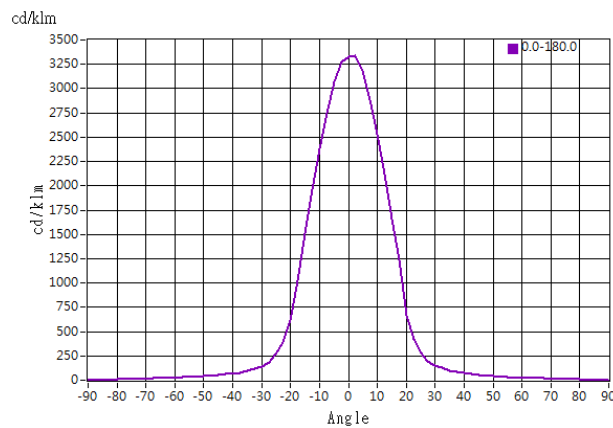

Illuminance At Distances

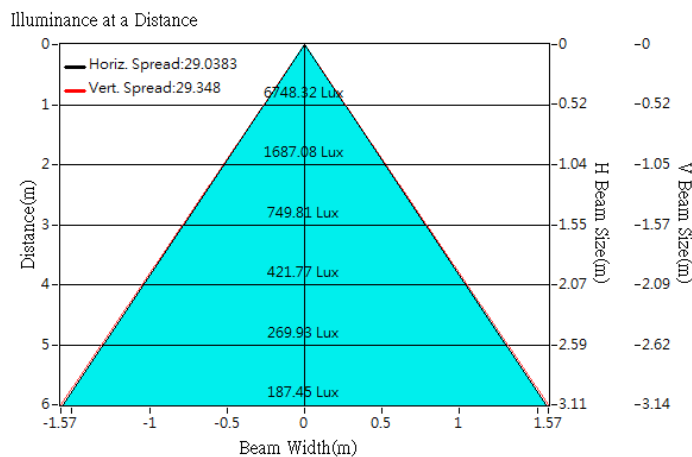



Lens Accessories - CoB Holder

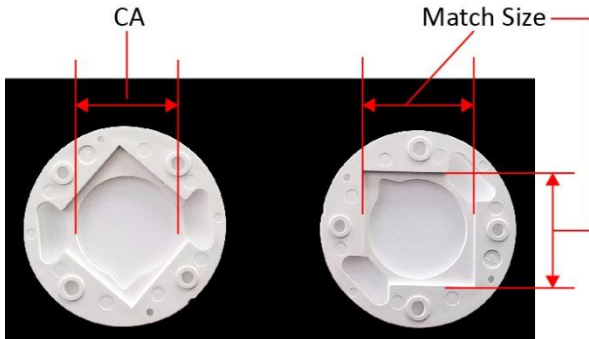

Example of LES Area & LED Size Dimension Locations

Product Model	Match Size (mm)	CA (mm)	Material	Applicability
CKO-HC14-161911-0501	16.3 x 19.3	Φ 11.9	PBT	Lumileds 1202
CKO-HC14-161911-0501	16.3 x 19.3	Φ 11.9	PBT	Lumileds 1203
CKO-HC14-202419-0502	20.3 x 24.3	Φ 19.2	PBT	Lumileds 1204
CKO-HC14-202419-0502	20.3 x 24.3	Φ 19.2	PBT	Lumileds 1205