



Product Model Number

CKO-CS15-075033-4008

✓ Model Number Definitions

CKO-XXXX-XXXXXX-XXXX

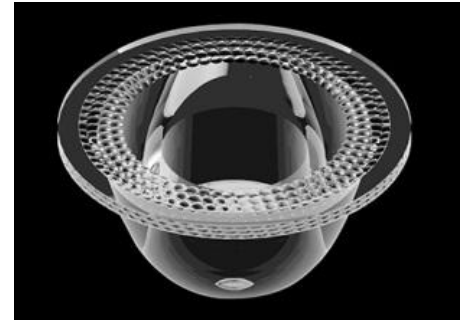

- A. Chun Kuang Optics Corp. Product
- B. Product Type: product abbreviation
Ex:
CH→CoB High Intensity
CC→CoB Compact
CS→Soft Shading for CoB LED
HC→Holder for CoB LED

- C. Identity Code
- D. Lens / Fixture Size
Ex: 075026=Φ75mm / Thickness=26mm (round up)
- E. Serial Numbers

The lens datasheet is applicable for **Citizen LED**, that manufactured by Chun Kuang Optics Corp.

✓ Dimensions (mm) : Φ75 x 33

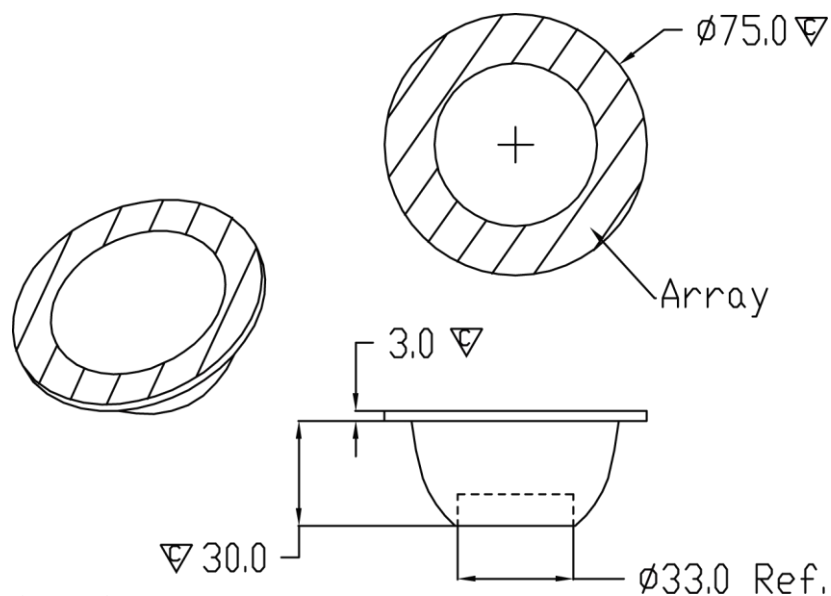

▽:Critical Dimension



✓ Optical Characteristics – Angle Performances

Citizen	LED LES (mm)	FWHM (degrees)	Field Angle (degrees)
CLU 711	Φ8.5	87°	114°
CLU 710	Φ8.5	82°	109°
CLU 026	Φ9.8	80°	111°
CLU 038	Φ14.5	82°	113°
CLU 036	Φ14.5	83°	114°
CLU 048	Φ22	81°	118°



Optical Characteristics

Model Number	CKO-CS15-075033-4008		<p>"H" definition</p>
LED	CLU 711		
LES / LED Size	Φ 8.5 mm		
FWHM (D50)	87°		
Field Angle (D10)	114°		
H (distance)	3.65 mm		
Dimension	Φ =75 mm, Thickness=33 mm		
Luminous Flux	2909 lm	Measured @ 25.7 W	
Material	PC / UL94V2		

cd/klm

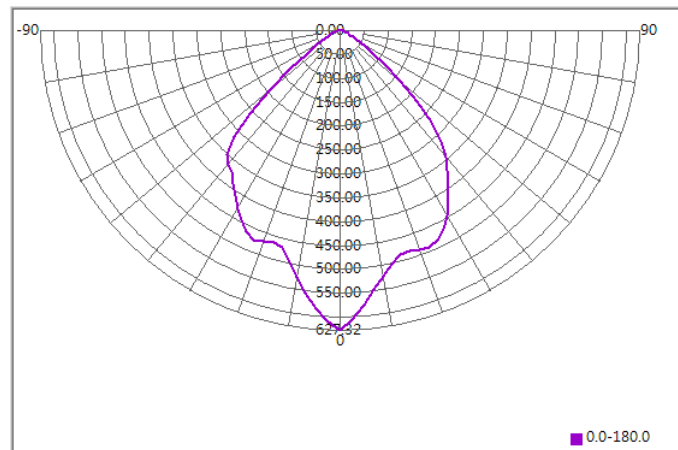

Illuminance At Distances

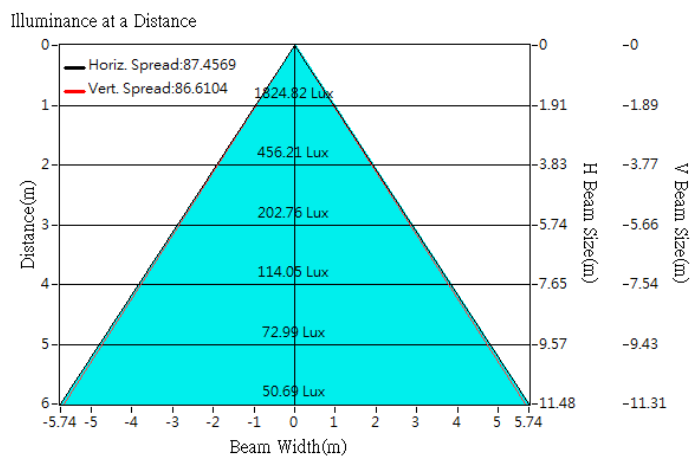



Optical Characteristics

Model Number	CKO-CS15-075033-4008		<p>"H" definition</p>
LED	CLU 710		
LES / LED Size	Φ 8.5 mm		
FWHM (D50)	76°		
Field Angle (D10)	107°		
H (distance)	4.0 mm		
Dimension	Φ =75 mm, Thickness=33 mm		
Luminous Flux	2511 lm	Measured @ 26.4 W	
Material	PC / UL94V2		

cd/klm

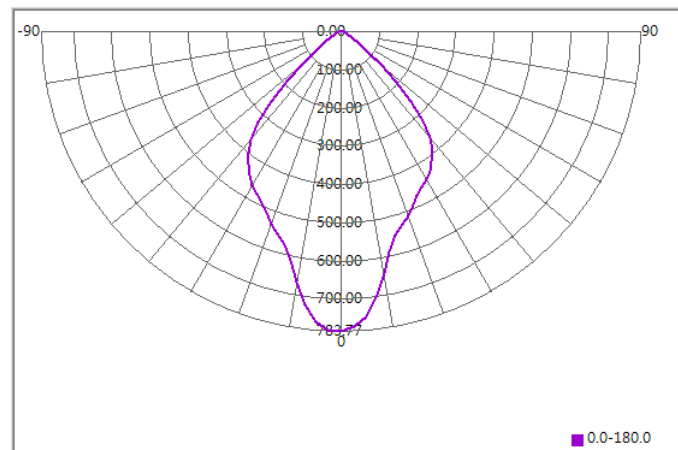

Illuminance At Distances

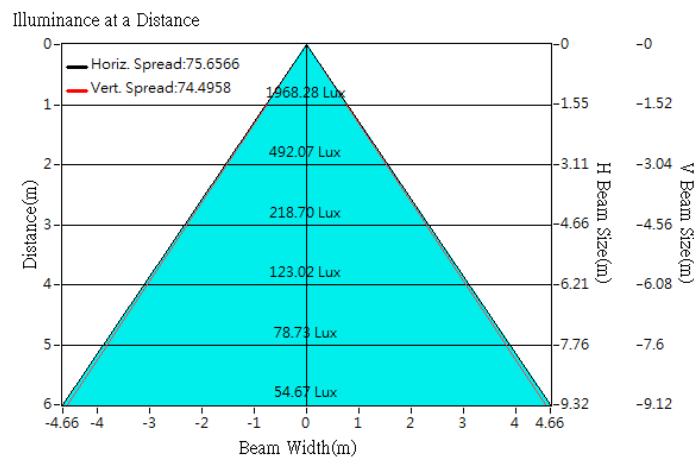



Optical Characteristics

Model Number	CKO-CS15-075033-4008		<p>"H" definition</p> <p>LES CoB</p>
LED	CLU 026		
LES / LED Size	Φ 9.8 mm		
FWHM (D50)	80°		
Field Angle (D10)	111°		
H (distance)	3.65 mm		
Dimension	Φ =75 mm, Thickness=33 mm		
Luminous Flux	1591 lm	Measured @ 12.3 W	
Material	PC / UL94V2		

cd/klm

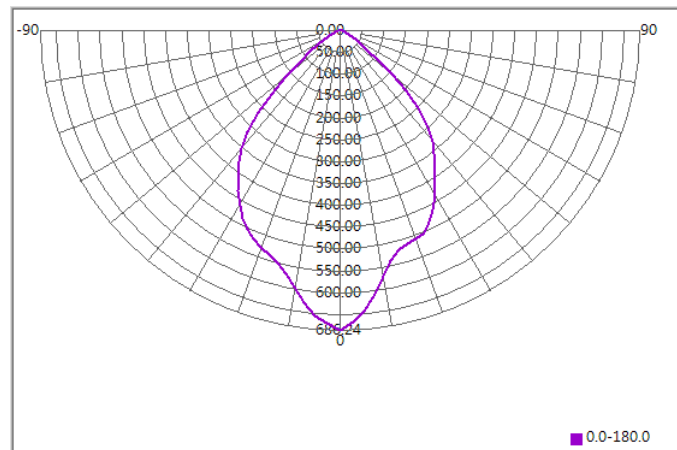

Illuminance At Distances

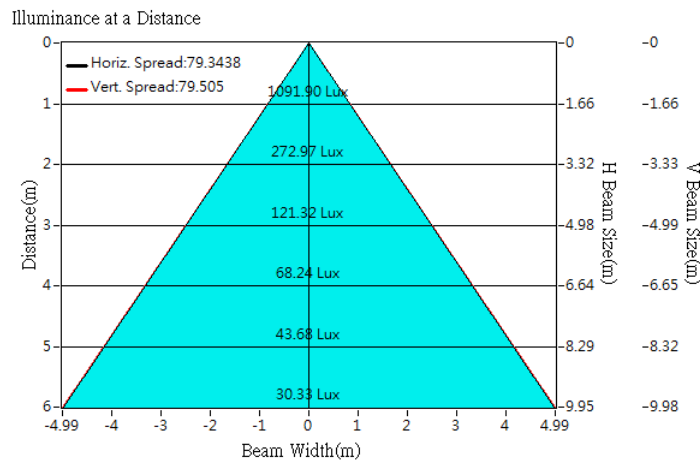



Optical Characteristics

Model Number	CKO-CS15-075033-4008		<p>"H" definition</p>
LED	CLU 036		
LES / LED Size	Φ 14.5 mm		
FWHM (D50)	83°		
Field Angle (D10)	114°		
H (distance)	3.65 mm		
Dimension	Φ =75 mm, Thickness=33 mm		
Luminous Flux	2038 lm	Measured @ 15.6 W	
Material	PC / UL94V2		

cd/klm

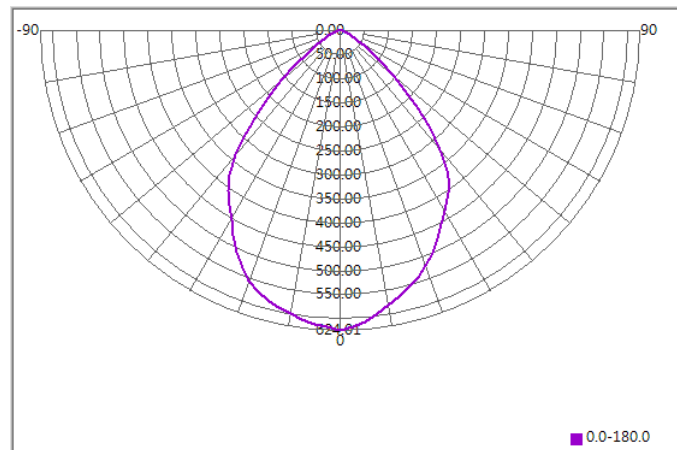

Illuminance At Distances

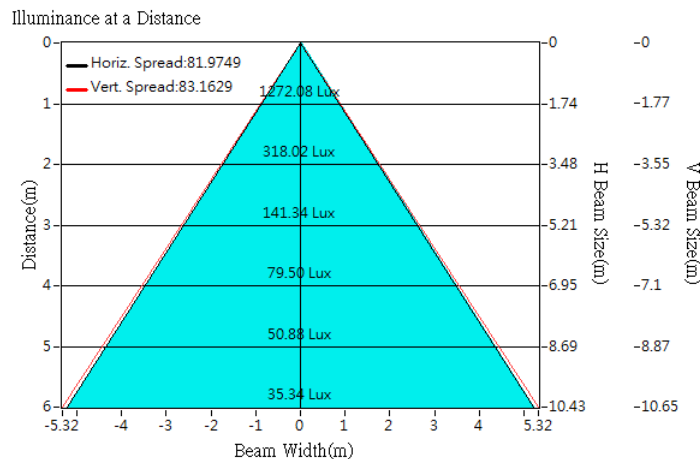



Optical Characteristics

Model Number	CKO-CS15-075033-4008		<p>"H" definition</p> <p>LES CoB</p>
LED	CLU 038		
LES / LED Size	Φ 14.5 mm		
FWHM (D50)	82°		
Field Angle (D10)	113°		
H (distance)	3.65 mm		
Dimension	Φ =75 mm, Thickness=33 mm		
Luminous Flux	2945 lm	Measured @ 25 W	
Material	PC / UL94V2		

cd/klm

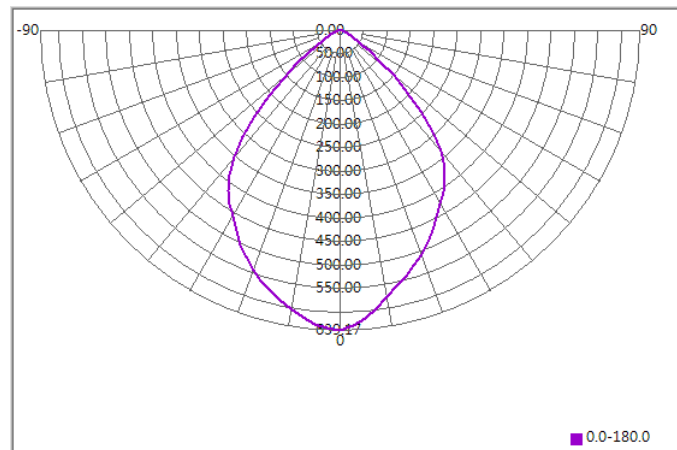

Illuminance At Distances

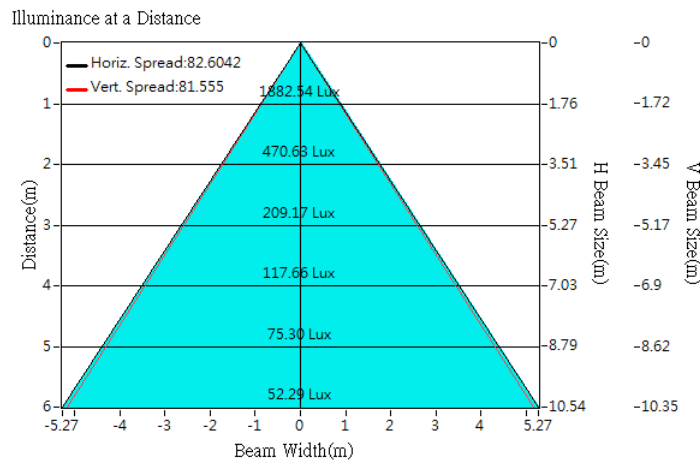



Optical Characteristics

Model Number	CKO-CS15-075033-4008		<p>"H" definition</p>
LED	CLU 048		
LES / LED Size	Φ 22 mm		
FWHM (D50)	81°		
Field Angle (D10)	118°		
H (distance)	3.65 mm		
Dimension	Φ =75 mm, Thickness=33 mm		
Luminous Flux	7283 lm	Measured @ 53.8 W	
Material	PC / UL94V2		

cd/klm

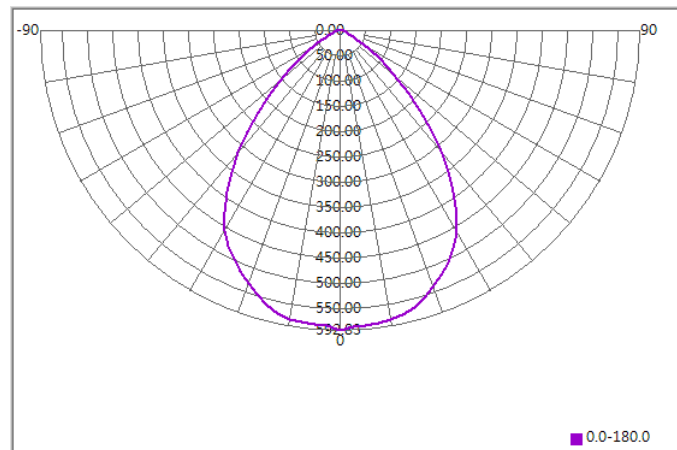

Illuminance At Distances

