



Product Model Number

CKO-CS15-075033-4060

✓ Model Number Definitions

CKO-XXXX-XXXXXX-XXXX

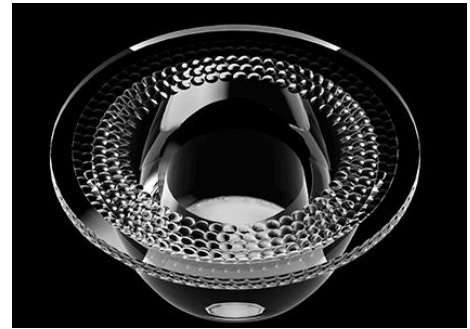

- A. Chun Kuang Optics Corp. Product
- B. Product Type: product abbreviation
Ex:
CH→CoB High Intensity
CC→CoB Compact
CS→Soft Shading for CoB LED
HC→Holder for CoB LED

- C. Identity Code
- D. Lens / Fixture Size
Ex: 075026=Φ75mm / Thickness=26mm (round up)
- C. Serial Numbers

The lens datasheet is applicable for **Luminus LED**, that manufactured by Chun Kuang Optics Corp.

✓ Dimensions (mm) : Φ75 x 33

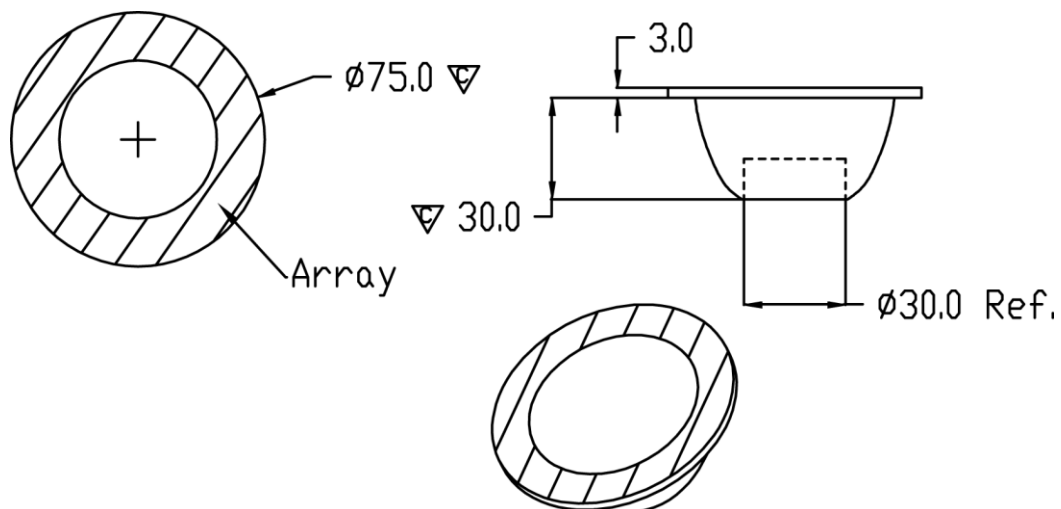

▽:Critical Dimension



Optical Characteristics

Model Number	CKO-CS15-075033-4060		<p>"H" definition</p>
LED	CXM-9-AC40		
LES / LED Size	Φ 9.8 mm		
FWHM (D50)	66°		
Field Angle (D10)	100°		
H (distance)	3.65 mm		
Dimension	Φ =75 mm, Thickness= 33 mm		
Luminous Flux	1402 lm	Measured @ 12.1 W	
Material	PC / UL94V2		

cd/klm

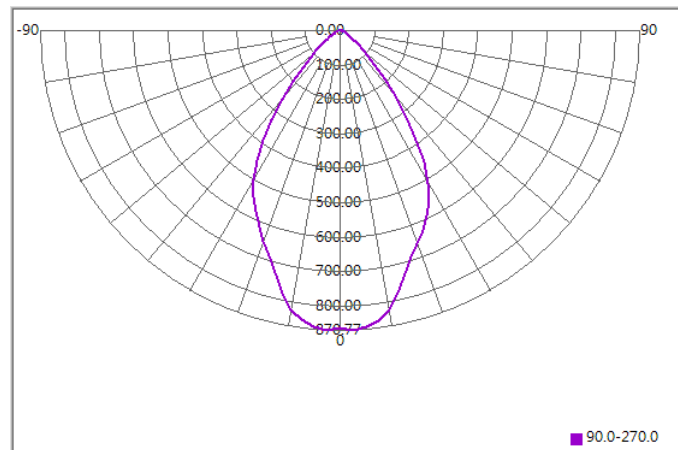

Illuminance At Distances

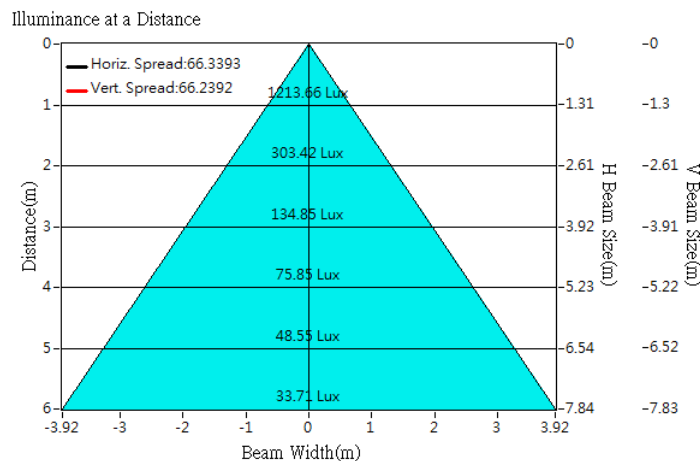



Optical Characteristics

Model Number	CKO-CS15-075033-4060		<p>"H" definition</p>
LED	CXM-11-AC30		
LES / LED Size	Φ 11.7 mm		
FWHM (D50)	68°		
Field Angle (D10)	104°		
H (distance)	3.65 mm		
Dimension	Φ =75 mm, Thickness= 33 mm		
Luminous Flux	1652 lm	Measured @ 15.5 W	
Material	PC / UL94V2		

cd/klm

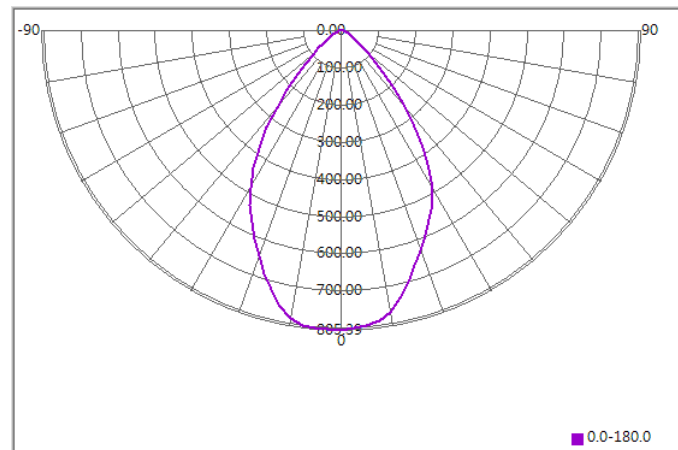

Illuminance At Distances

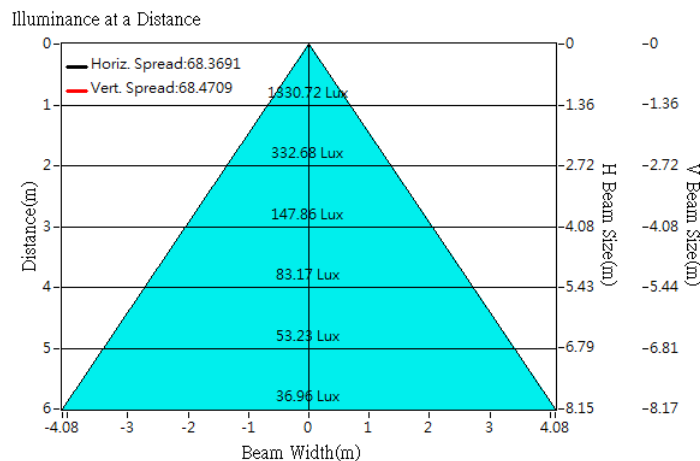



Optical Characteristics

Model Number	CKO-CS15-075033-4060		<p>"H" definition</p>
LED	CLM-14-AC40		
LES / LED Size	Φ 14.5 mm		
FWHM (D50)	67°		
Field Angle (D10)	103°		
H (distance)	3.65 mm		
Dimension	Φ =75 mm, Thickness= 33 mm		
Luminous Flux	2513 lm	Measured @ 16.6 W	
Material	PC / UL94V2		

cd/klm

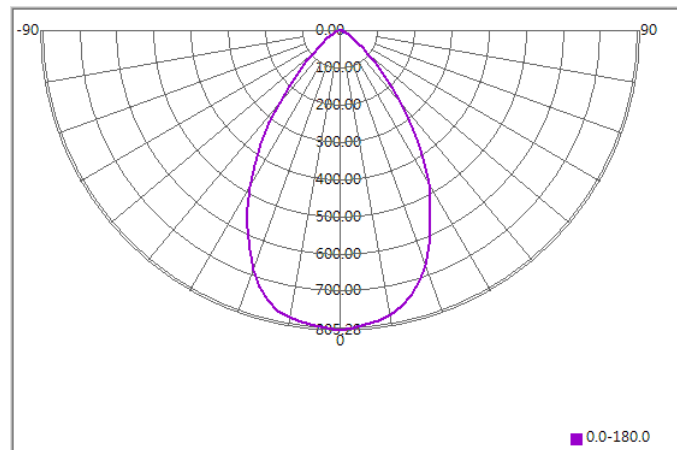

Illuminance At Distances

