



Product Model Number

CKO-CS17-045021-1301

✓ Model Number Definitions

CKO-XXXX-XXXXXX-XXXX



- A. Chun Kuang Optics Corp. Product
- B. Product Type: product abbreviation
Ex:
CH→CoB High Intensity
CC→CoB Compact
SA→Soft Shading for CoB LED - Asymmetry
HC→Holder for CoB LED

- C. Identity Code
- D. Lens / Fixture Size
Ex: 075026=Φ75mm / Thickness=26mm (round up)
- E. Serial Numbers

The lens datasheet is applicable for **Luminus LED**, that manufactured by Chun Kuang Optics Corp.

✓ Dimensions (mm) : Φ45 x 20.9

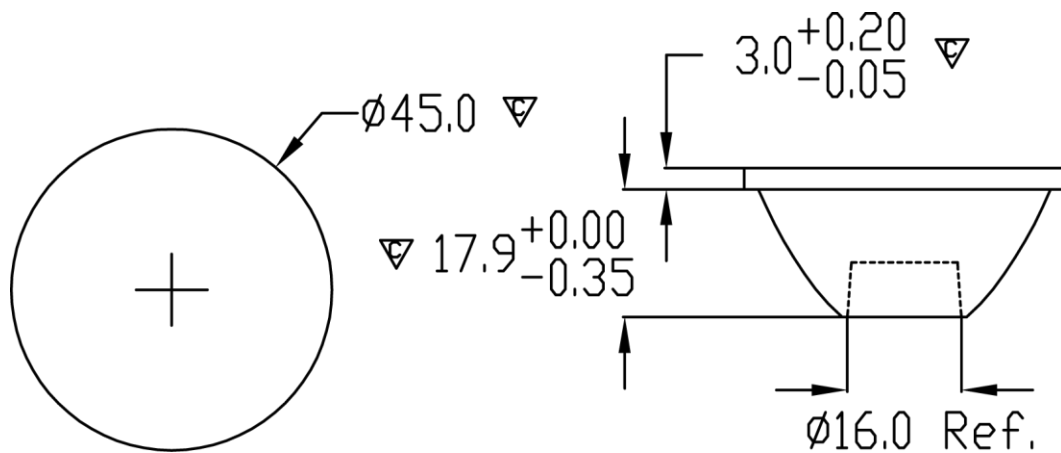

∇:Critical Dimension



Optical Characteristics

Model Number	CKO-CS17-045021-1301		<p>"H" definition</p>
LED	CXM-3-AC40		
LES / LED Size	Φ 3.5 mm		
FWHM (D50)	9°		
Field Angle (D10)	26°		
H (distance)	2.5mm		
Dimension	Φ =45 mm, Thickness=20.9 mm		
Luminous Flux	297 lm	Measured @ 2.7 W	
Material	PC / UL94V2		

cd/klm

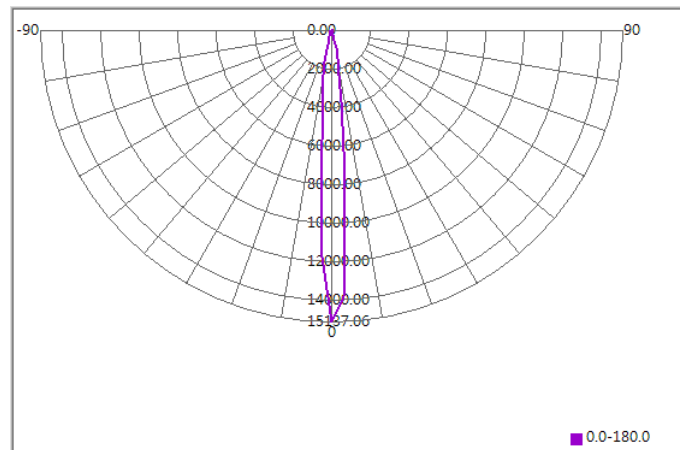

Illuminance At Distances

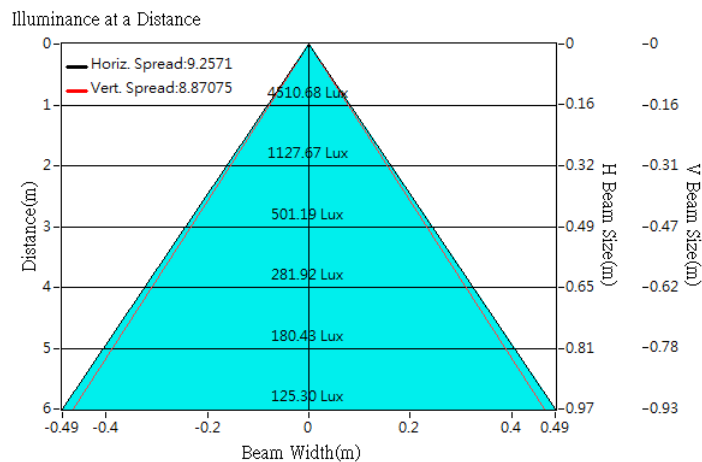



Optical Characteristics

Model Number	CKO-CS17-045021-1301		<p>"H" definition</p> <p>LES CoB</p>
LED	CXM-4-AC40		
LES / LED Size	Φ 4.5 mm		
FWHM (D50)	11°		
Field Angle (D10)	28°		
H (distance)	2.5mm		
Dimension	Φ =45 mm, Thickness=20.9 mm		
Luminous Flux	464 lm	Measured @ 4.0 W	
Material	PC / UL94V2		

cd/klm

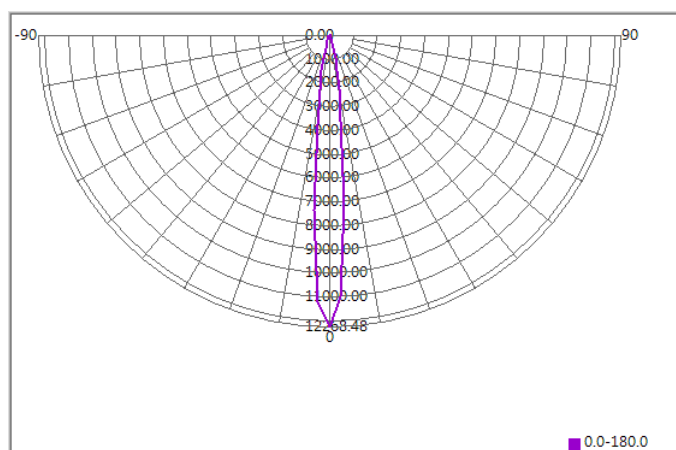

Illuminance At Distances

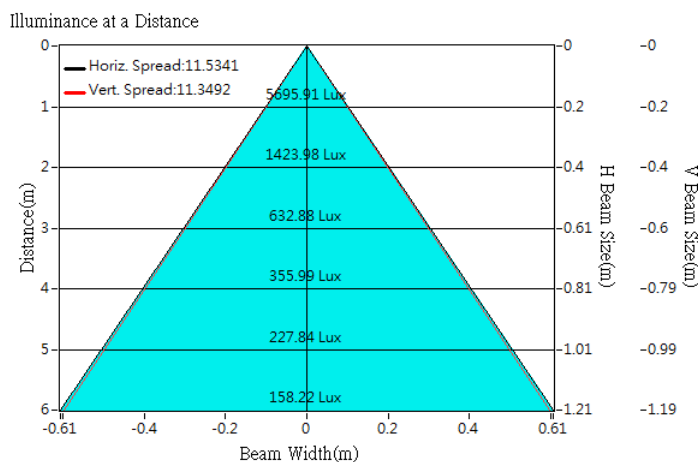

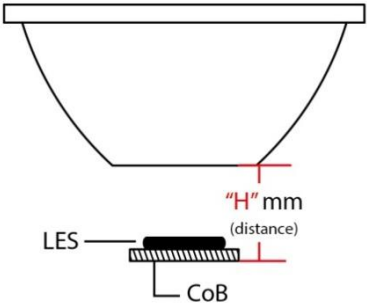

Optical Characteristics

Model Number	CKO-CS17-045021-1301		<p>"H" definition</p> 
LED	CXM-6-AC40		
LES / LED Size	Φ 6.3 mm		
FWHM (D50)	15°		
Field Angle (D10)	36°		
H (distance)	2.5mm		
Dimension	Φ =45 mm, Thickness=20.9 mm		
Luminous Flux	744 lm	Measured @ 5.5 W	
Material	PC / UL94V2		

cd/klm

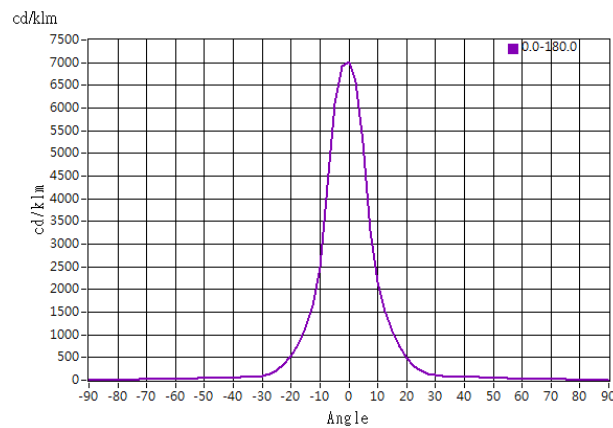

Illuminance At Distances

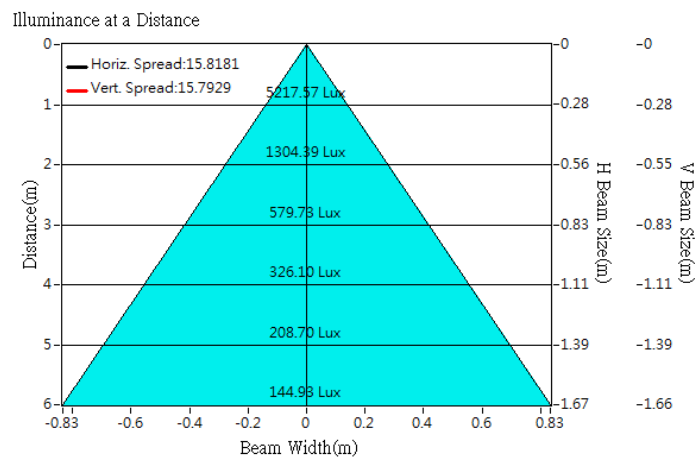



Optical Characteristics

Model Number	CKO-CS17-045021-1301		<p>"H" definition</p>
LED	CXM-9-AC30		
LES / LED Size	Φ 9.6 mm		
FWHM (D50)	21°		
Field Angle (D10)	46°		
H (distance)	2.5mm		
Dimension	Φ =45 mm, Thickness=20.9 mm		
Luminous Flux	1345 lm	Measured @ 12.1 W	
Material	PC / UL94V2		

cd/klm

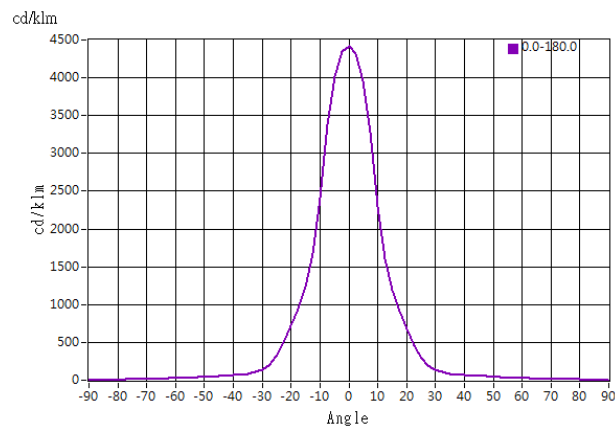

Illuminance At Distances

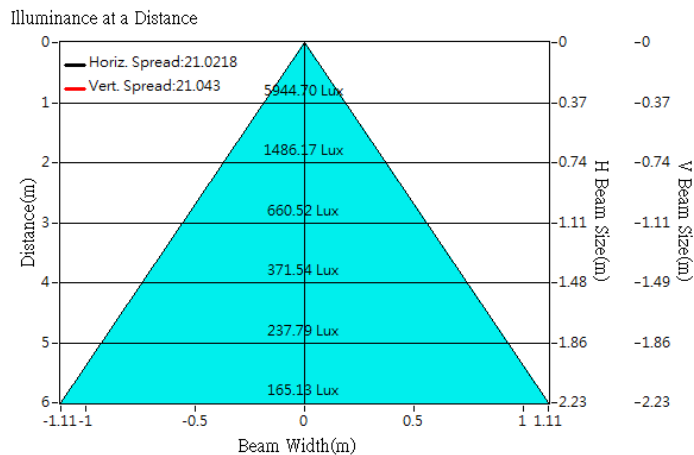



Optical Characteristics

Model Number	CKO-CS17-045021-1301		<p>"H" definition</p>
LED	CXM-9-AC40		
LES / LED Size	Φ 9.8 mm		
FWHM (D50)	22°		
Field Angle (D10)	47°		
H (distance)	2.5mm		
Dimension	Φ =45 mm, Thickness=20.9 mm		
Luminous Flux	1353 lm	Measured @ 12.4 W	
Material	PC / UL94V2		

cd/klm

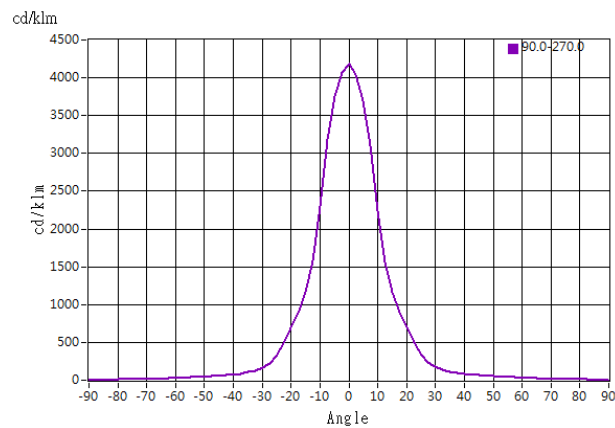

Illuminance At Distances

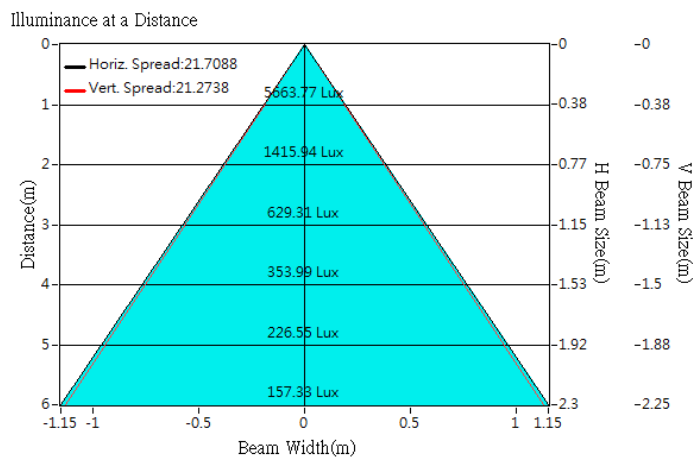



Optical Characteristics

Model Number	CKO-CS17-045021-1301		<p>"H" definition</p>
LED	CXM-11-AC30		
LES / LED Size	Φ 11.7 mm		
FWHM (D50)	25°		
Field Angle (D10)	53°		
H (distance)	2.5mm		
Dimension	Φ =45 mm, Thickness=20.9 mm		
Luminous Flux	1641 lm	Measured @ 15.7 W	
Material	PC / UL94V2		

cd/klm

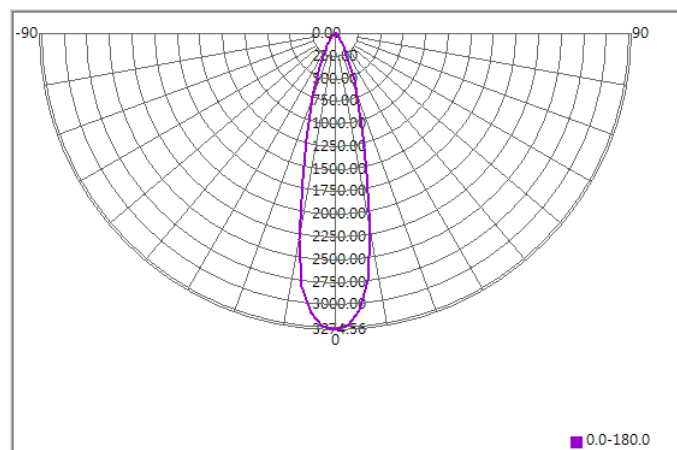

Illuminance At Distances

