



Product Model Number

CKO-CS17-045021-1360

✓ Model Number Definitions

CKO-XXXX-XXXXXX-XXXX

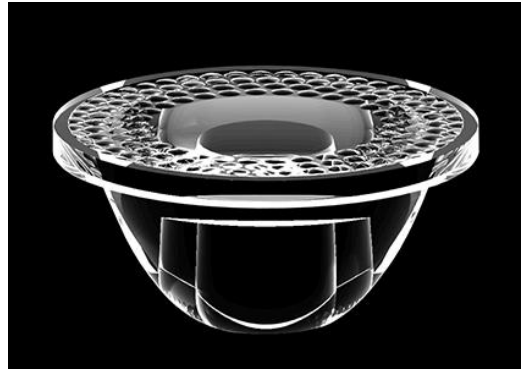

- A. Chun Kuang Optics Corp. Product
- B. Product Type: product abbreviation
Ex:
CH→CoB High Intensity
CC→CoB Compact
CS→Soft Shading for CoB LED
HC→Holder for CoB LED

- C. Identity Code
- D. Lens / Fixture Size
Ex: 075026=Φ75mm / Thickness=26mm (round up)
- E. Serial Numbers

The lens datasheet is applicable for **Citizen LED**, that manufactured by Chun Kuang Optics Corp.

✓ Dimensions (mm) : Φ45 x 20.9

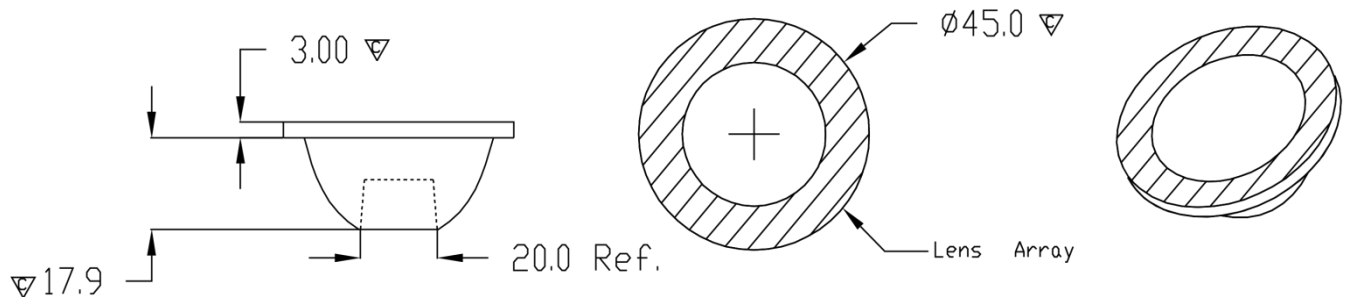

▽:Critical Dimension



Optical Characteristics

Model Number	CKO-CS17-045021-1360		<p>"H" definition</p>
LED	CLU 701		
LES / LED Size	Φ 6 mm		
FWHM (D50)	54°		
Field Angle (D10)	82°		
H (distance)	2.5mm		
Dimension	Φ =45 mm, Thickness=20.9 mm		
Luminous Flux	1035 lm	Measured @ 10.8 W	
Material	PC / UL94V2		

cd/klm

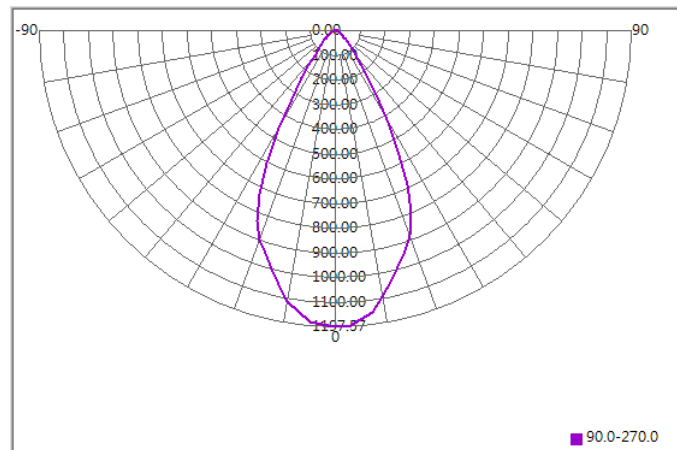

Illuminance At Distances

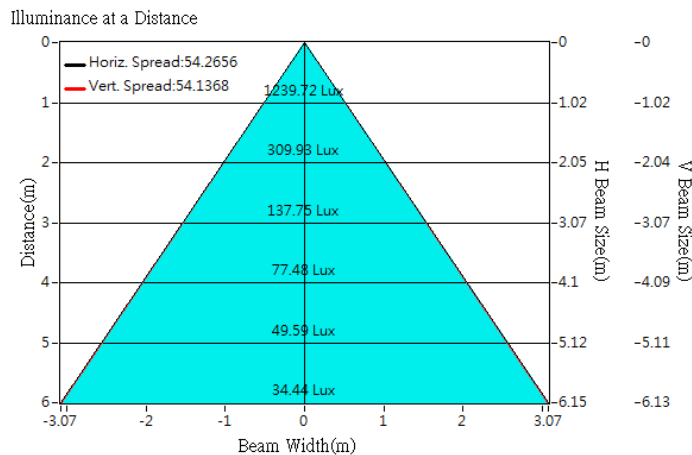

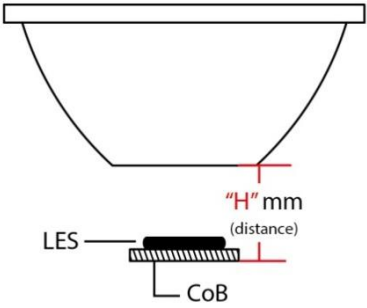

Optical Characteristics

Model Number	CKO-CS17-045021-1360		<p>"H" definition</p> 
LED	CLU 711		
LES / LED Size	Φ 8.5 mm		
FWHM (D50)	53°		
Field Angle (D10)	81°		
H (distance)	2.5mm		
Dimension	Φ =45 mm, Thickness=20.9 mm		
Luminous Flux	2819 lm	Measured @ 26.6 W	
Material	PC / UL94V2		

cd/klm

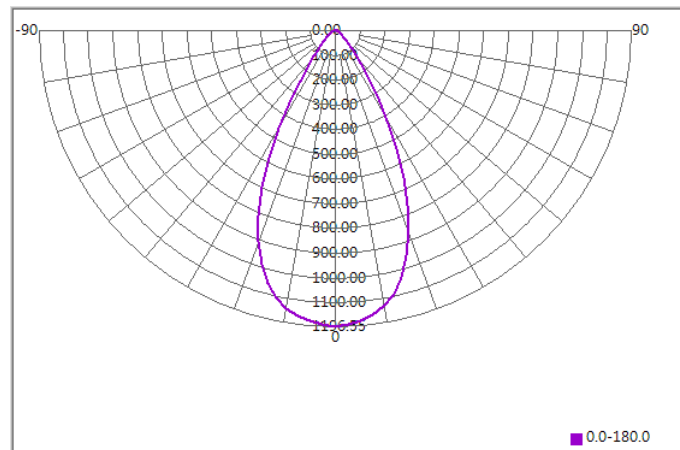

Illuminance At Distances

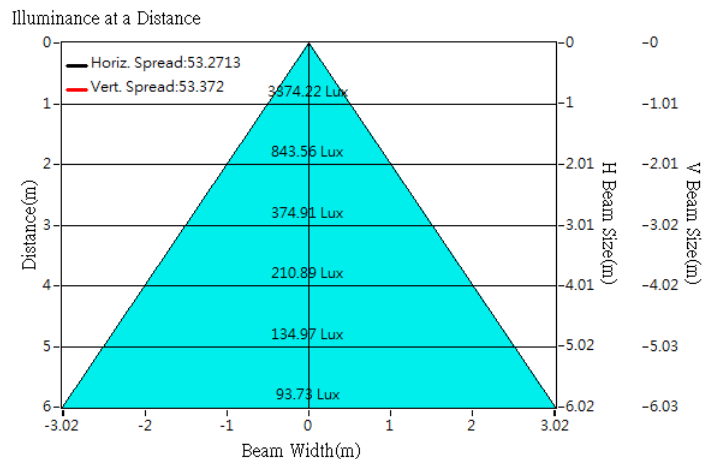



Optical Characteristics

Model Number	CKO-CS17-045021-1360		<p>"H" definition</p>
LED	CLU 710		
LES / LED Size	Φ 8.5 mm		
FWHM (D50)	54°		
Field Angle (D10)	82°		
H (distance)	2.5mm		
Dimension	Φ =45 mm, Thickness=20.9 mm		
Luminous Flux	2590 lm	Measured @ 27.4 W	
Material	PC / UL94V2		

cd/klm

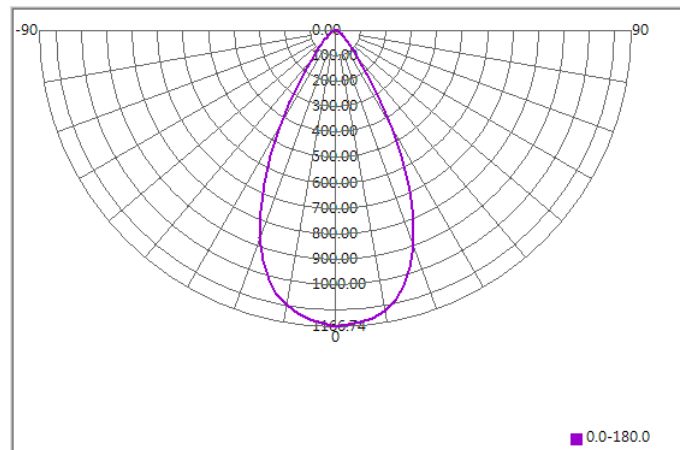

Illuminance At Distances

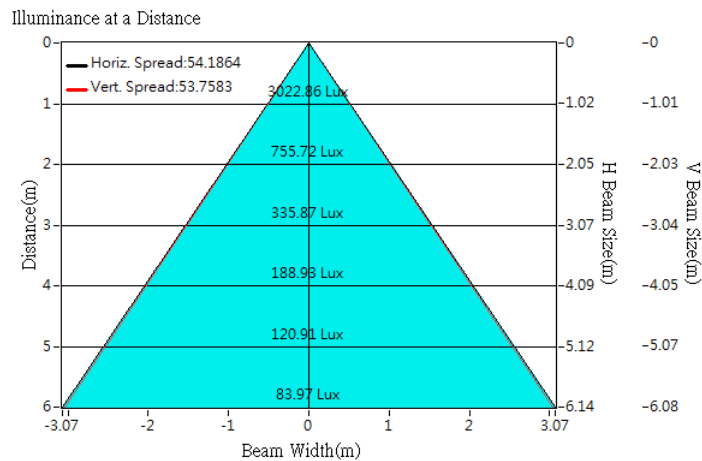



Optical Characteristics

Model Number	CKO-CS17-045021-1360		<p>"H" definition</p>
LED	CLU 028		
LES / LED Size	Φ 9.8 mm		
FWHM (D50)	55°		
Field Angle (D10)	84°		
H (distance)	2.5mm		
Dimension	Φ =45 mm, Thickness=20.9 mm		
Luminous Flux	1611 lm	Measured @ 12.9 W	
Material	PC / UL94V2		

cd/klm

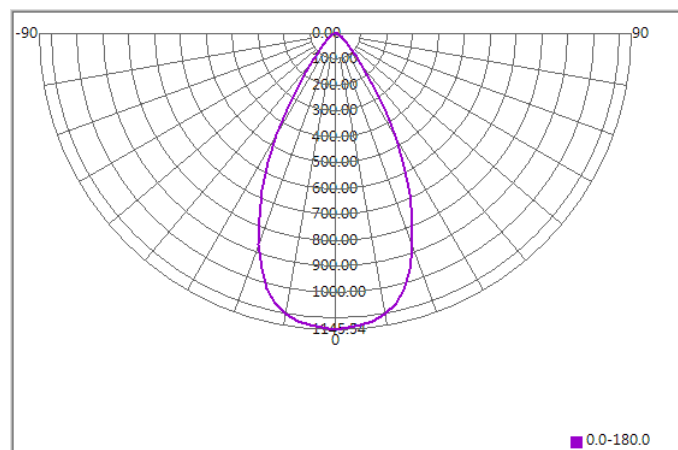

Illuminance At Distances

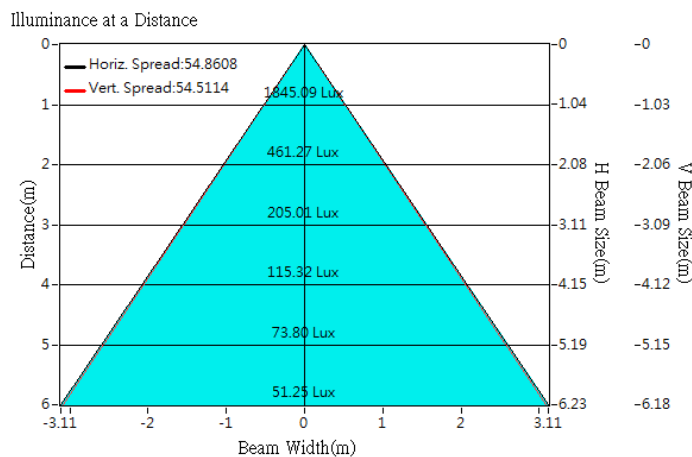



Optical Characteristics

Model Number	CKO-CS17-045021-1360		<p>"H" definition</p>
LED	CLU 026		
LES / LED Size	Φ 9.8 mm		
FWHM (D50)	54°		
Field Angle (D10)	84°		
H (distance)	2.5mm		
Dimension	Φ =45 mm, Thickness=20.9 mm		
Luminous Flux	1652 lm	Measured @ 12.4 W	
Material	PC / UL94V2		

cd/klm

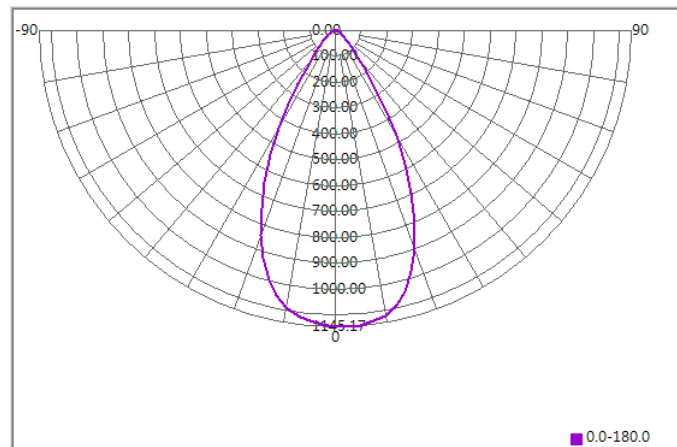

Illuminance At Distances

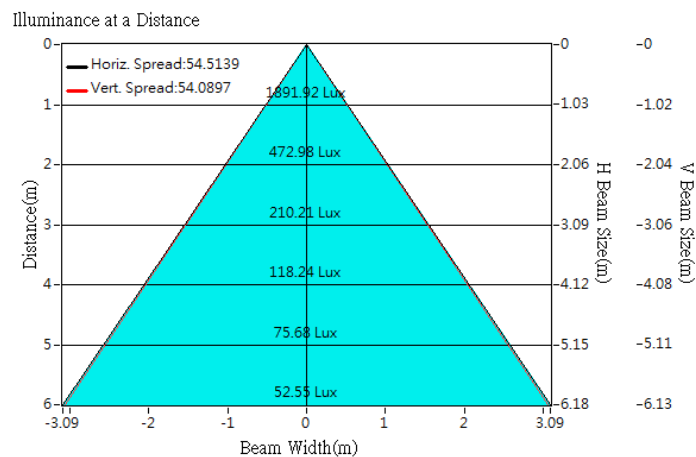



Optical Characteristics

Model Number	CKO-CS17-045021-1360		<p>"H" definition</p>
LED	CLU 721		
LES / LED Size	Φ 11 mm		
FWHM (D50)	53°		
Field Angle (D10)	82°		
H (distance)	2.5mm		
Dimension	Φ =45 mm, Thickness=20.9 mm		
Luminous Flux	4043 lm	Measured @ 38.0 W	
Material	PC / UL94V2		

cd/klm

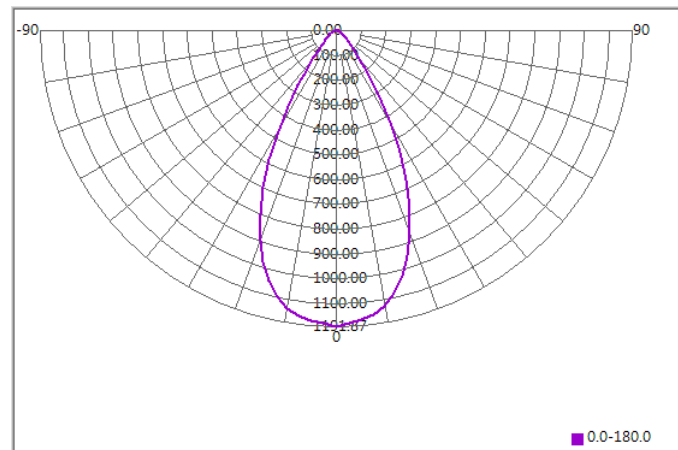

Illuminance At Distances

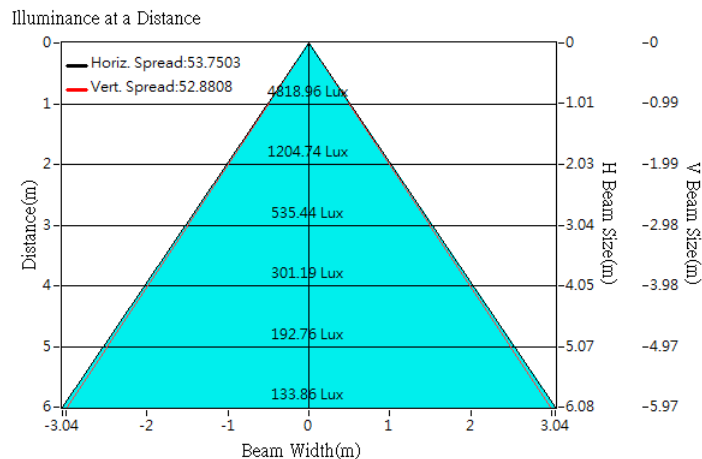



Optical Characteristics

Model Number	CKO-CS17-045021-1360		<p>"H" definition</p> <p>LES CoB</p>
LED	CLU 720		
LES / LED Size	Φ 11 mm		
FWHM (D50)	54°		
Field Angle (D10)	84°		
H (distance)	2.5mm		
Dimension	Φ =45 mm, Thickness=20.9 mm		
Luminous Flux	3454 lm	Measured @ 39.0 W	
Material	PC / UL94V2		

cd/klm

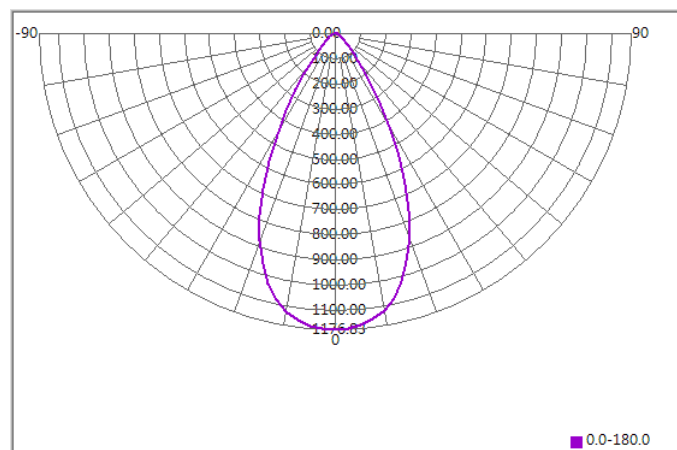

Illuminance At Distances

