



Product Model Number

CKO-CS18-035018-1303

✓ Model Number Definitions

CKO-XXXX-XXXXXX-XXXX



- A. Chun Kuang Optics Corp. Product
- B. Product Type: product abbreviation
Ex:
CH→CoB High Intensity
CC→CoB Compact
CS→Soft Shading for CoB LED
HC→Holder for CoB LED

- C. Identity Code
- D. Lens / Fixture Size
Ex: 075026=Φ75mm / Thickness=26mm (round up)
- E. Serial Numbers

The lens datasheet is applicable for **Luminus LED**, that manufactured by Chun Kuang Optics Corp.

✓ Dimensions (mm) : Φ35 x 17.4

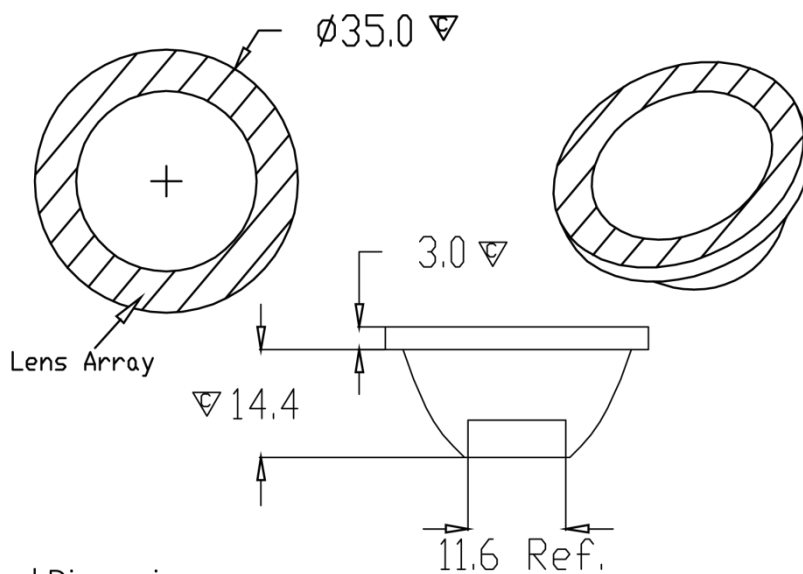

▽:Critical Dimension



✓ Optical Characteristics – Angle Performances

Luminus	LED LES (mm)	FWHM (degrees)	Field Angle (degrees)
CXM-3-AC40	Φ3.5	19°	39°
CXM-4-AC40	Φ4.5	22°	44°
CXM-6-AC40	Φ6.3	25°	52°
CXM-9-AC30	Φ9.6	31°	63°
CXM-9-AC40	Φ9.8	31°	65°
CXM-11-AC30	Φ11.7	34°	71°



Optical Characteristics

Model Number	CKO-CS18-035018-1303		<p>"H" definition</p> <p>LES CoB</p>
LED	CXM-3-AC40		
LES / LED Size	Φ 3.5 mm		
FWHM (D50)	19°		
Field Angle (D10)	39°		
H (distance)	2.5 mm		
Dimension	Φ =35 mm, Thickness= 17.4 mm		
Luminous Flux	290 lm	Measured @ 2.8 W	
Material	PC / UL94V2		

cd/klm

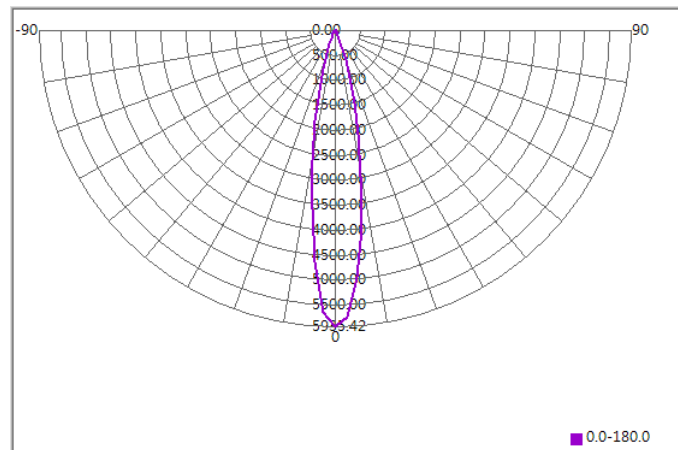

Illuminance At Distances

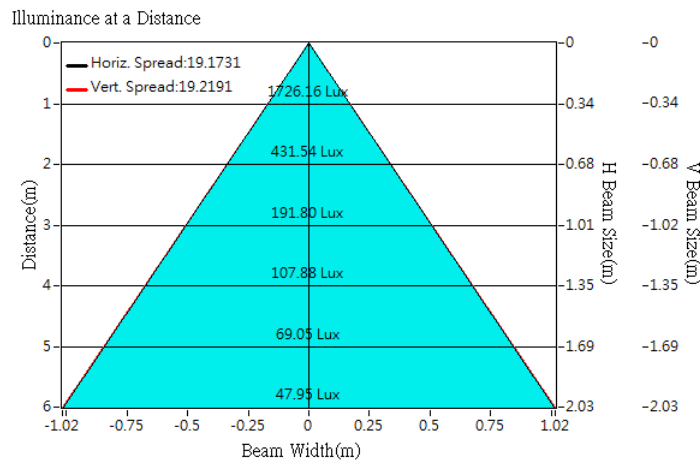



Optical Characteristics

Model Number	CKO-CS18-035018-1303		<p>"H" definition</p>
LED	CXM-4-AC40		
LES / LED Size	Φ 4.5 mm		
FWHM (D50)	22°		
Field Angle (D10)	44°		
H (distance)	2.5 mm		
Dimension	Φ =35 mm, Thickness= 17.4 mm		
Luminous Flux	475 lm	Measured @ 4.0 W	
Material	PC / UL94V2		

cd/klm

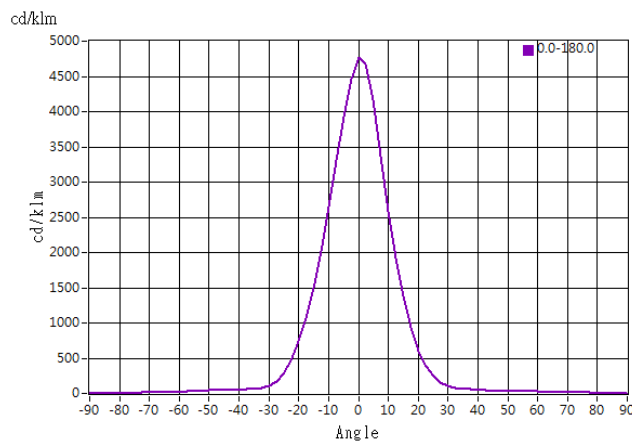

Illuminance At Distances

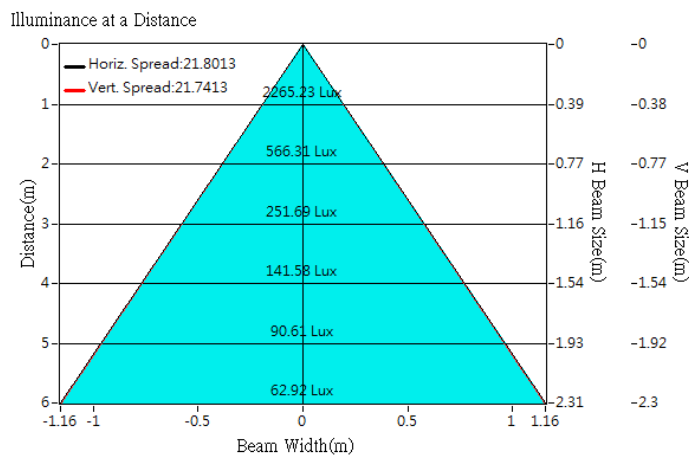



Optical Characteristics

Model Number	CKO-CS18-035018-1303		<p>"H" definition</p>
LED	CXM-6-AC40		
LES / LED Size	Φ 6.3 mm		
FWHM (D50)	25°		
Field Angle (D10)	52°		
H (distance)	2.5 mm		
Dimension	Φ =35 mm, Thickness= 17.4 mm		
Luminous Flux	718 lm	Measured @ 5.1 W	
Material	PC / UL94V2		

cd/klm

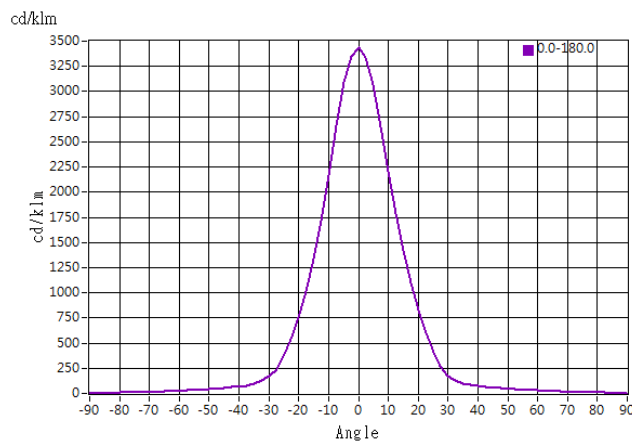

Illuminance At Distances

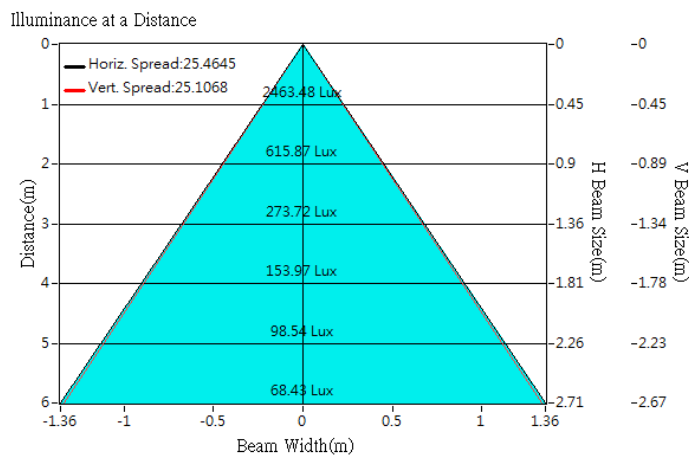



Optical Characteristics

Model Number	CKO-CS18-035018-1303		<p>"H" definition</p>
LED	CXM-9-AC30		
LES / LED Size	Φ 9.6 mm		
FWHM (D50)	31°		
Field Angle (D10)	63°		
H (distance)	2.5 mm		
Dimension	Φ =35 mm, Thickness= 17.4 mm		
Luminous Flux	1372 lm	Measured @ 12.1 W	
Material	PC / UL94V2		

cd/klm

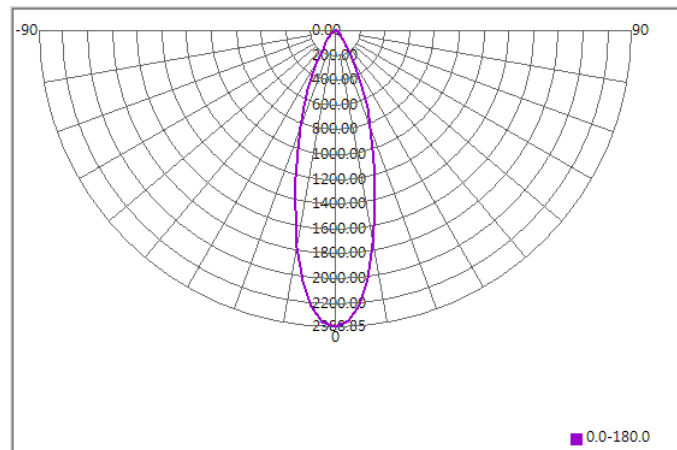

Illuminance At Distances

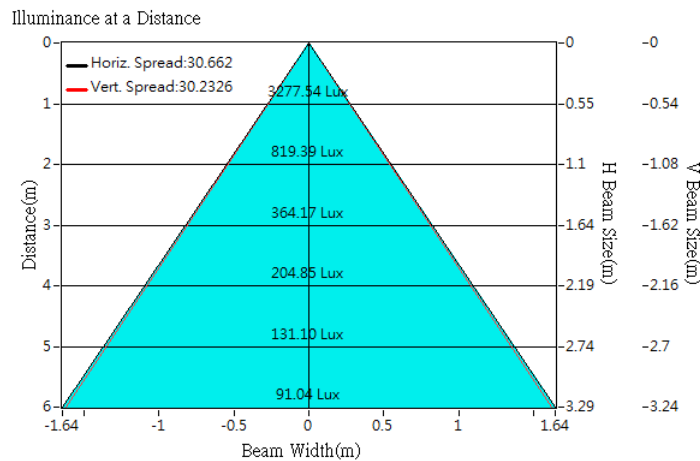



Optical Characteristics

Model Number	CKO-CS18-035018-1303		<p>"H" definition</p> <p>LES CoB</p>
LED	CXM-9-AC40		
LES / LED Size	Φ 9.8 mm		
FWHM (D50)	31°		
Field Angle (D10)	65°		
H (distance)	2.5 mm		
Dimension	Φ =35 mm, Thickness= 17.4 mm		
Luminous Flux	1350 lm	Measured @ 12.3 W	
Material	PC / UL94V2		

cd/klm

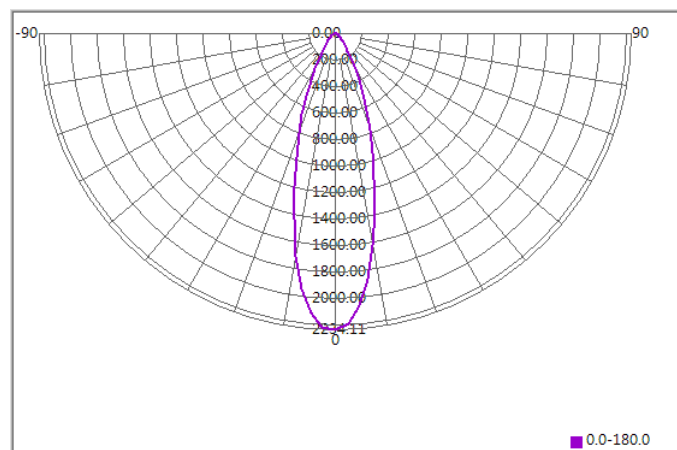

Illuminance At Distances

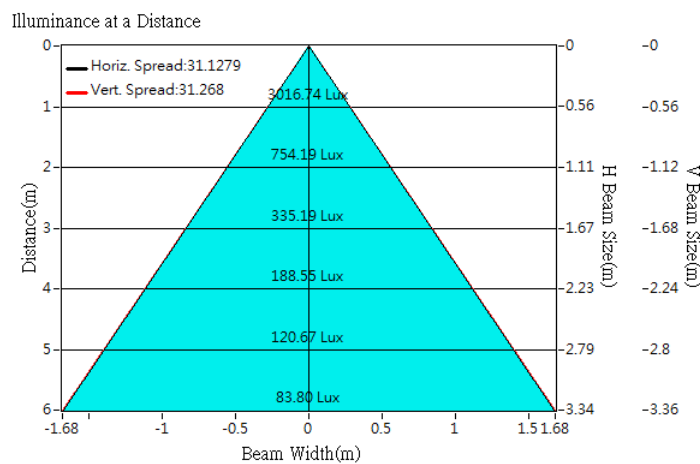



Optical Characteristics

Model Number	CKO-CS18-035018-1303		<p>"H" definition</p>
LED	CXM-11-AC30		
LES / LED Size	Φ 11.7 mm		
FWHM (D50)	34°		
Field Angle (D10)	71°		
H (distance)	2.5 mm		
Dimension	Φ =35 mm, Thickness= 17.4 mm		
Luminous Flux	1659 lm	Measured @ 15.0 W	
Material	PC / UL94V2		

cd/klm

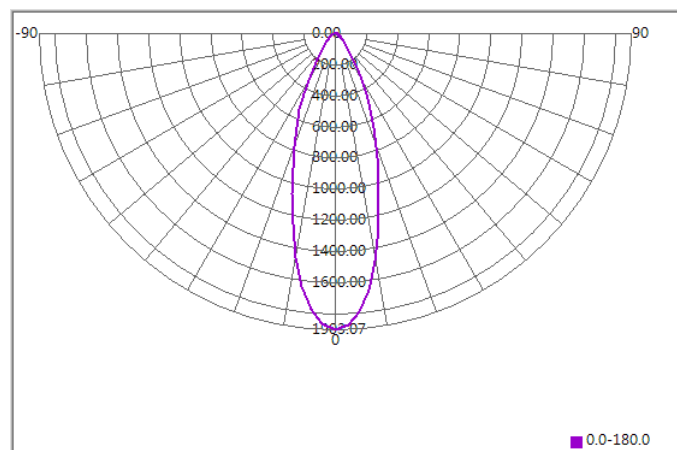

Illuminance At Distances

