



Product Model Number

CKO-CU15-034009-9900

✓ Model Number Definitions

CKO-XXXX-XXXXXX-XXXX



- A. Chun Kuang Optics Corp. Product
- B. Product Type: product abbreviation
Ex:
CH→CoB High Intensity
CC→CoB Compact
CS→Soft Shading for CoB LED
HC→Holder for CoB LED

- C. Identity Code
- D. Lens / Fixture Size
Ex: 075026=Φ75mm / Thickness=26mm (round up)
- C. Serial Numbers

The lens datasheet is applicable for **Philips LED**, that manufactured by Chun Kuang Optics Corp.

✓ Dimensions (mm) : Φ33.9 x 8.2

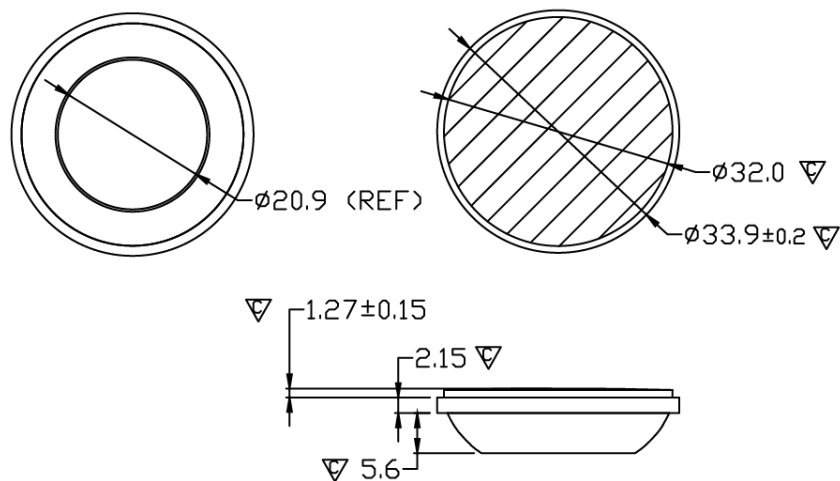

▽:Critical Dimension



✓ **Optical Characteristics – Angle Performances**

Philips	LED LES (mm)	FWHM (degrees)	Field Angle (degrees)
Fortimo SLM 1202 L06 G7	Φ6.5	24°	46°
Fortimo SLM 1202 L06 G6	Φ6.5	24°	48°
Fortimo SLM 1203 L09 G6	Φ9	30°	63°
Fortimo SLM PW 1204 L09 G7	Φ9	27°	59°



Optical Characteristics

Model Number	CKO-CU15-034009-9900		<p>"H" definition</p>
LED	Fortimo SLM 1202 L06 G7		
LES / LED Size	Φ 6.5 mm		
FWHM (D50)	24°		
Field Angle (D10)	46°		
H (distance)	2.4 mm		
Dimension	Φ =33.9 mm, Thickness= 8.2 mm		
Luminous Flux	1362 lm	Measured @ 13.1 W	
Material	PC / UL94V2		

cd/klm

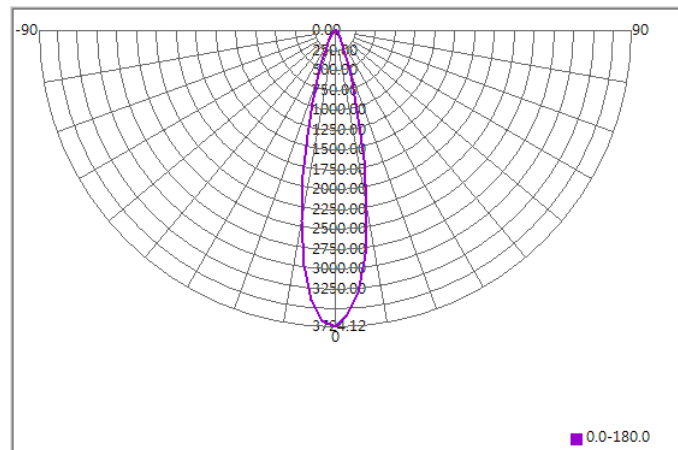

Illuminance At Distances

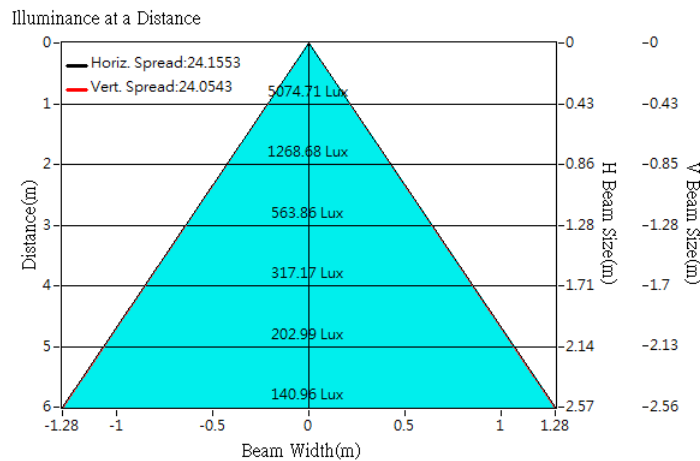



Optical Characteristics

Model Number	CKO-CU15-034009-9900		<p>"H" definition</p>
LED	Fortimo SLM 1202 L06 G6		
LES / LED Size	Φ 6.5 mm		
FWHM (D50)	24°		
Field Angle (D10)	48°		
H (distance)	2.4 mm		
Dimension	Φ =33.9 mm, Thickness= 8.2 mm		
Luminous Flux	821 lm	Measured @ 7.2 W	
Material	PC / UL94V2		

cd/klm

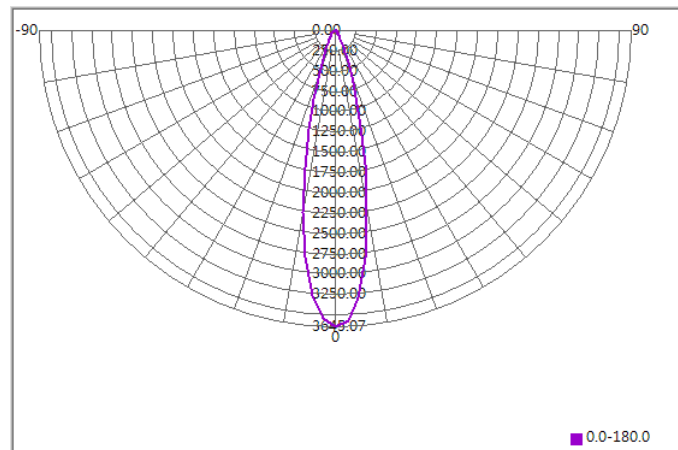

Illuminance At Distances

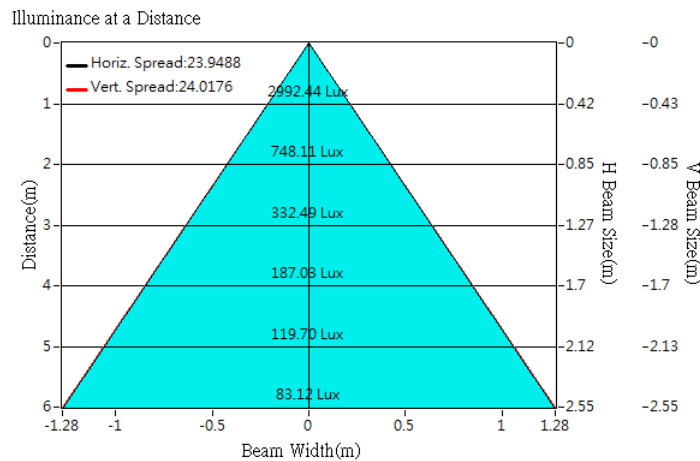



Optical Characteristics

Model Number	CKO-CU15-034009-9900		<p>"H" definition</p>
LED	Fortimo SLM 1203 L09 G6		
LES / LED Size	Φ 9 mm		
FWHM (D50)	30°		
Field Angle (D10)	63°		
H (distance)	2.4 mm		
Dimension	Φ =33.9 mm, Thickness= 8.2 mm		
Luminous Flux	1275 lm	Measured @ 10.4 W	
Material	PC / UL94V2		

cd/klm

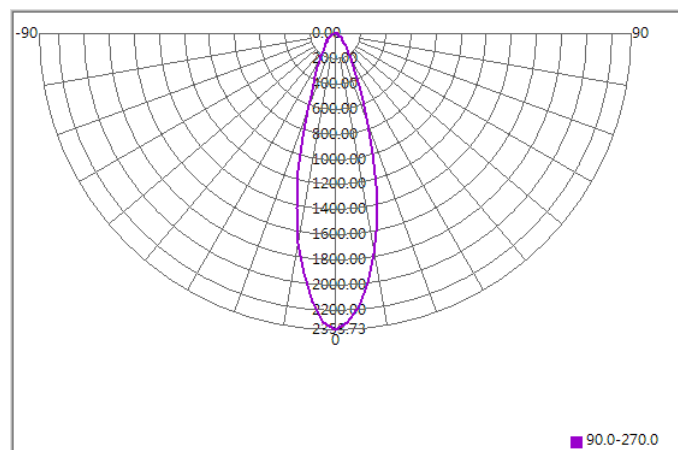

Illuminance At Distances

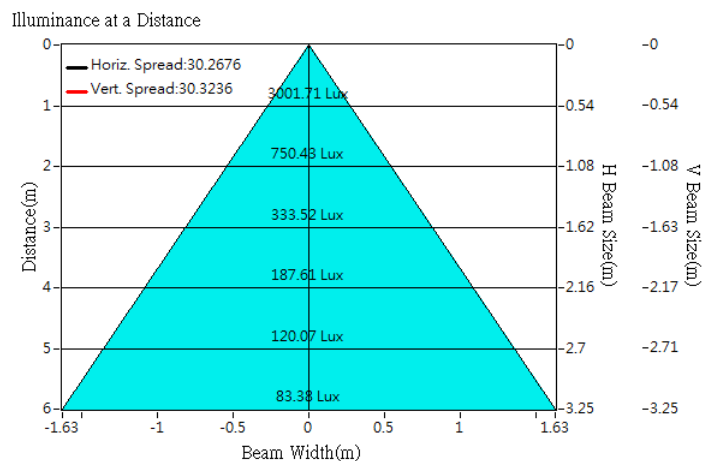



Optical Characteristics

Model Number	CKO-CU15-034009-9900		<p>"H" definition</p>
LED	Fortimo SLM PW 1204 L09 G7		
LES / LED Size	Φ 9 mm		
FWHM (D50)	27°		
Field Angle (D10)	59°		
H (distance)	2.4 mm		
Dimension	Φ =33.9 mm, Thickness= 8.2 mm		
Luminous Flux	2379 lm	Measured @ 26.7 W	
Material	PC / UL94V2		

cd/klm

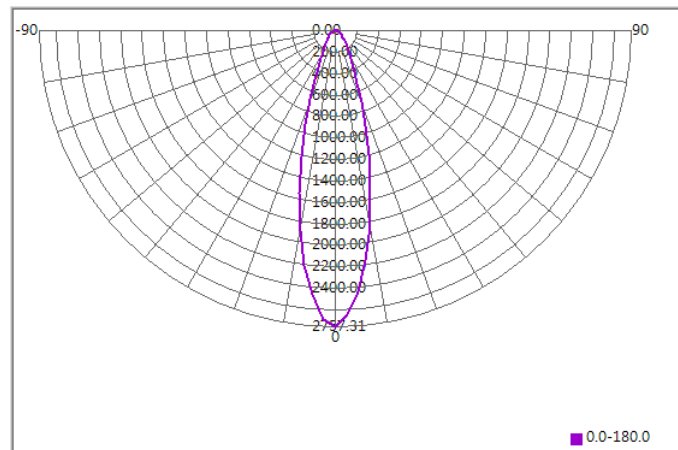

Illuminance At Distances

