



Product Model Number

CKO-CU15-034009-9911

✓ Model Number Definitions

CKO-XXXX-XXXXXX-XXXX



- A. Chun Kuang Optics Corp. Product
- B. Product Type: product abbreviation
Ex:
CH→CoB High Intensity
CC→CoB Compact
CS→Soft Shading for CoB LED
HC→Holder for CoB LED

- C. Identity Code
- D. Lens / Fixture Size
Ex: 075026=Φ75mm / Thickness=26mm (round up)
- C. Serial Numbers

The lens datasheet is applicable for **Ciziten LED**, that manufactured by Chun Kuang Optics Corp.

✓ Dimensions (mm) : Φ33.9 x 8.2

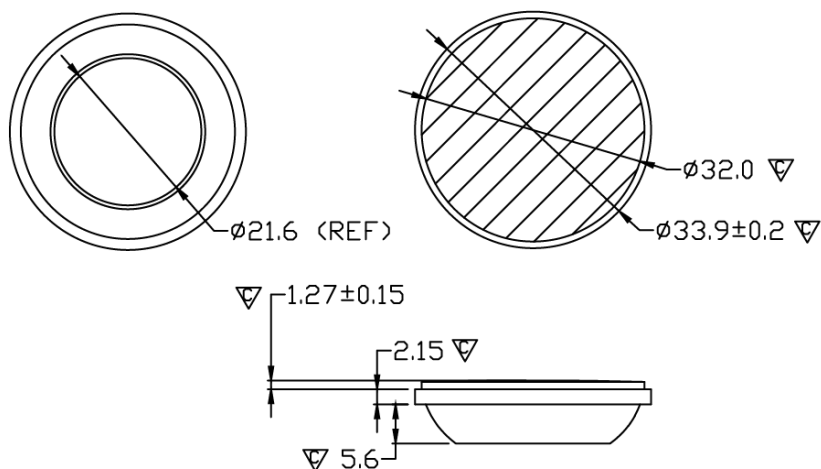

▽:Critical Dimension



Optical Characteristics

Model Number	CKO-CU15-034009-9911		<p>"H" definition</p> <p>LES CoB</p>
LED	CLU 701		
LES / LED Size	Φ 6 mm		
FWHM (D50)	58°		
Field Angle (D10)	104°		
H (distance)	2.4 mm		
Dimension	Φ =33.9 mm, Thickness= 8.2 mm		
Luminous Flux	1089 lm	Measured @ 10.9 W	
Material	PC / UL94V2		

cd/klm

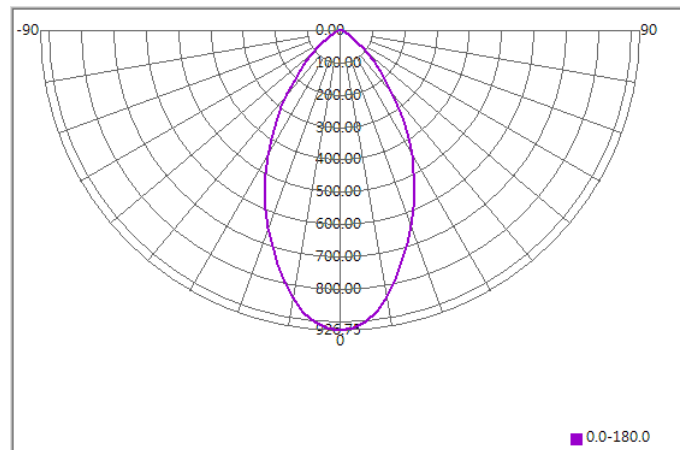

Illuminance At Distances

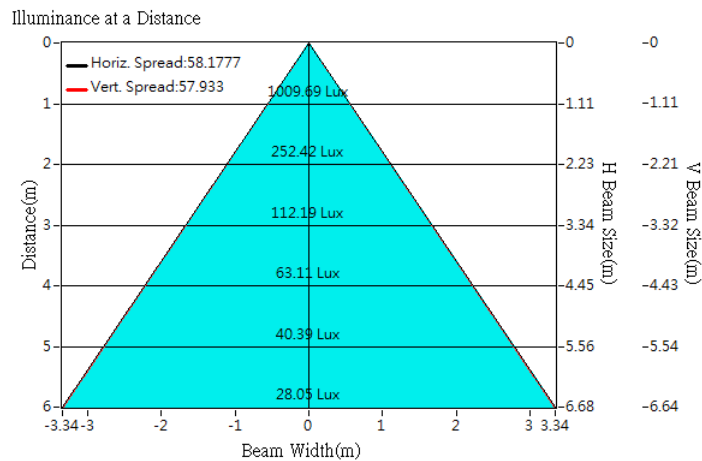



Optical Characteristics

Model Number	CKO-CU15-034009-9911		<p>"H" definition</p>
LED	CLU 700		
LES / LED Size	Φ 6 mm		
FWHM (D50)	64°		
Field Angle (D10)	108°		
H (distance)	2.4 mm		
Dimension	Φ =33.9 mm, Thickness= 8.2 mm		
Luminous Flux	1428 lm	Measured @ 14.5 W	
Material	PC / UL94V2		

cd/klm

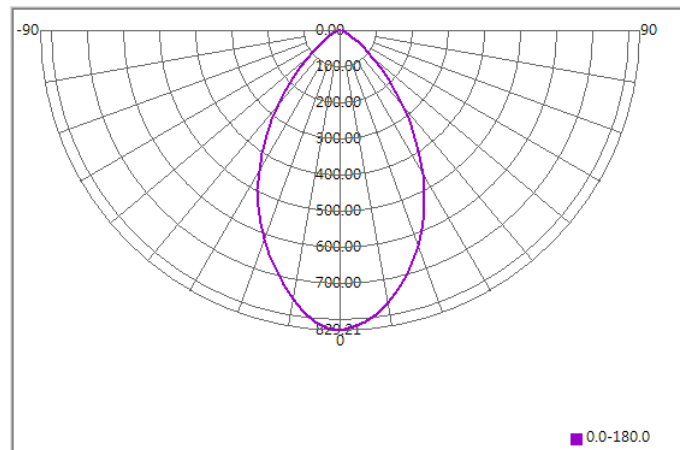

Illuminance At Distances

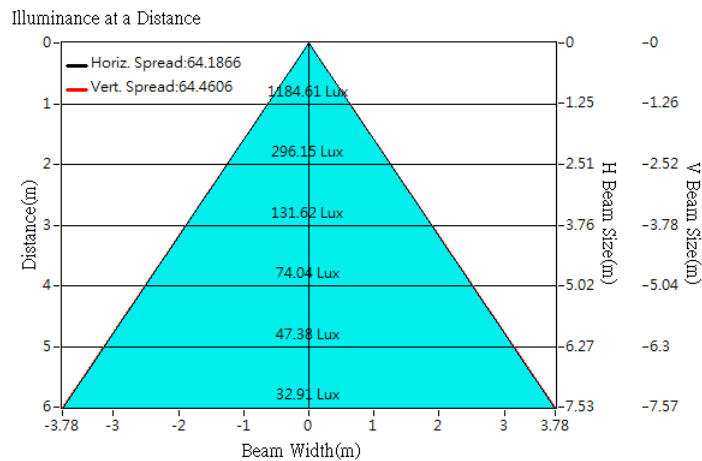



Optical Characteristics

Model Number	CKO-CU15-034009-9911		<p>"H" definition</p>
LED	CLU 711		
LES / LED Size	Φ 8.5 mm		
FWHM (D50)	63°		
Field Angle (D10)	107°		
H (distance)	2.4 mm		
Dimension	Φ =33.9 mm, Thickness= 8.2 mm		
Luminous Flux	2969 lm	Measured @ 25.7 W	
Material	PC / UL94V2		

cd/klm

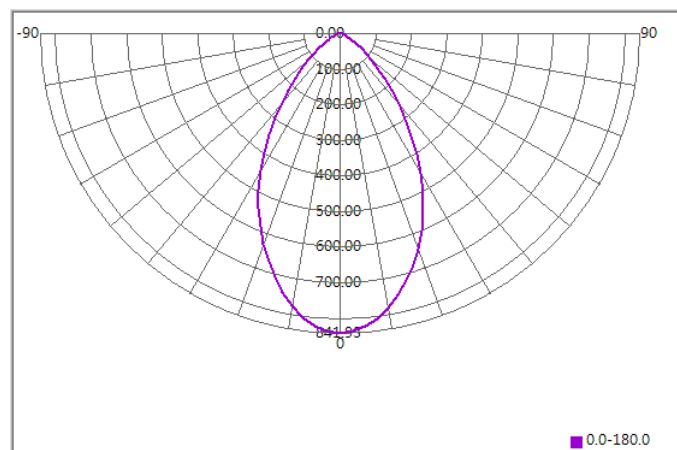

Illuminance At Distances

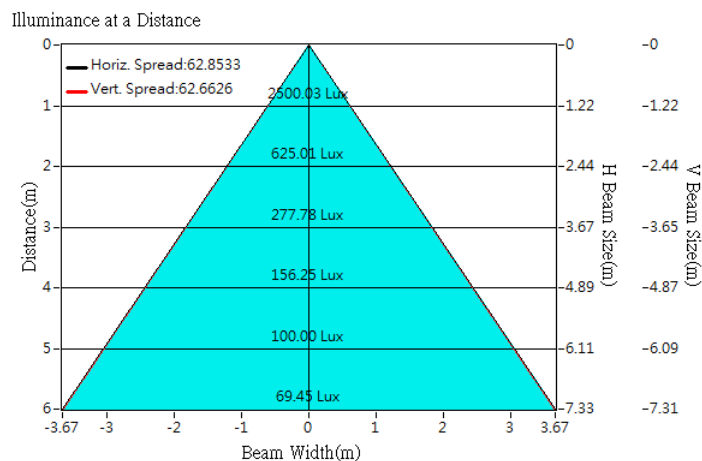



Optical Characteristics

Model Number	CKO-CU15-034009-9911	<p>"H" definition</p>
LED	CLU 710	
LES / LED Size	Φ 8.5 mm	
FWHM (D50)	65°	
Field Angle (D10)	109°	
H (distance)	2.4 mm	
Dimension	Φ =33.9 mm, Thickness= 8.2 mm	
Luminous Flux	2735 lm	
Material	PC / UL94V2	

cd/klm

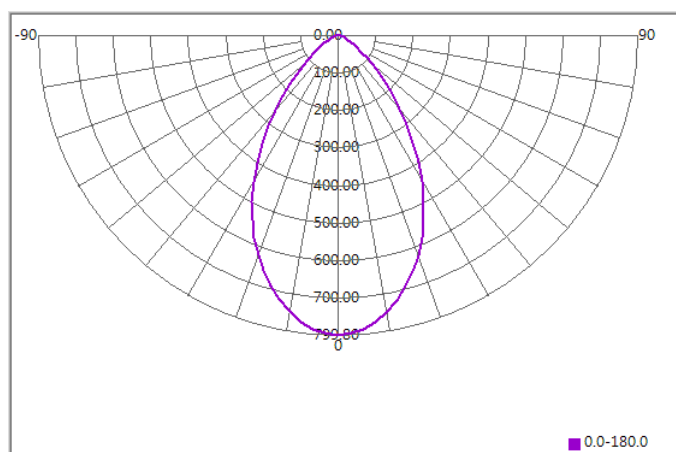

Illuminance At Distances

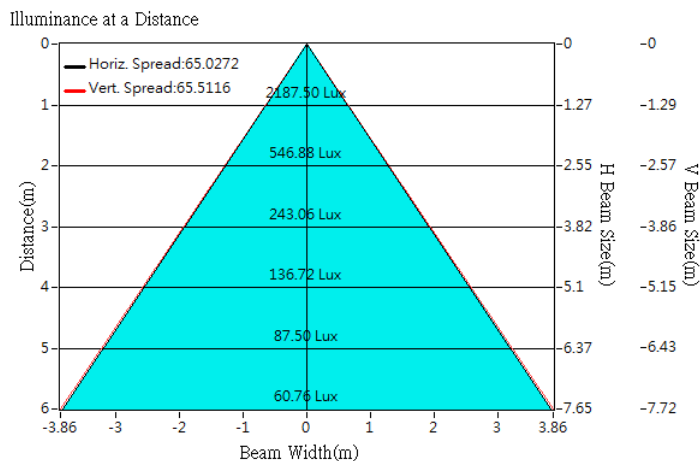



Optical Characteristics

Model Number	CKO-CU15-034009-9911		<p>"H" definition</p> <p>LES CoB</p>
LED	CLU 028		
LES / LED Size	Φ 9.8 mm		
FWHM (D50)	60°		
Field Angle (D10)	106°		
H (distance)	2.4 mm		
Dimension	Φ =33.9 mm, Thickness= 8.2 mm		
Luminous Flux	1758 lm	Measured @ 12.6 W	
Material	PC / UL94V2		

cd/klm

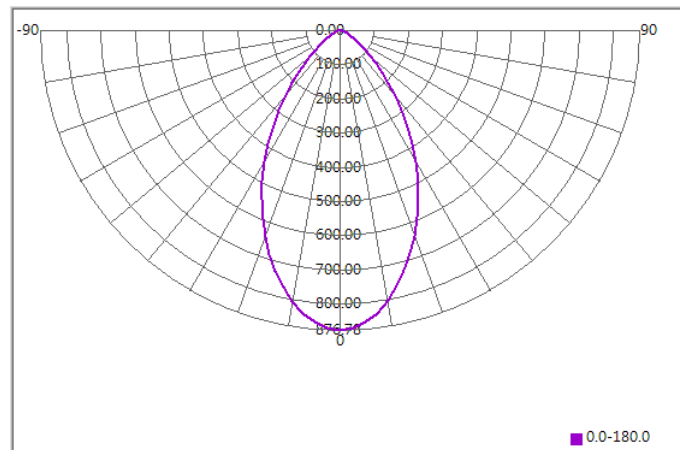

Illuminance At Distances

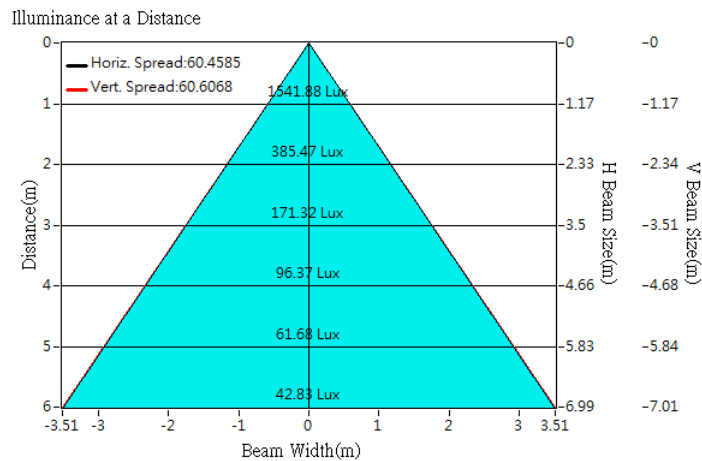



Optical Characteristics

Model Number	CKO-CU15-034009-9911	<p>"H" definition</p> <p>LES CoB</p>	
LED	CLU 026		
LES / LED Size	Φ 9.8 mm		
FWHM (D50)	61°		
Field Angle (D10)	107°		
H (distance)	2.4 mm		
Dimension	Φ =33.9 mm, Thickness= 8.2 mm		
Luminous Flux	1697 lm		Measured @ 12.5 W
Material	PC / UL94V2		

cd/klm

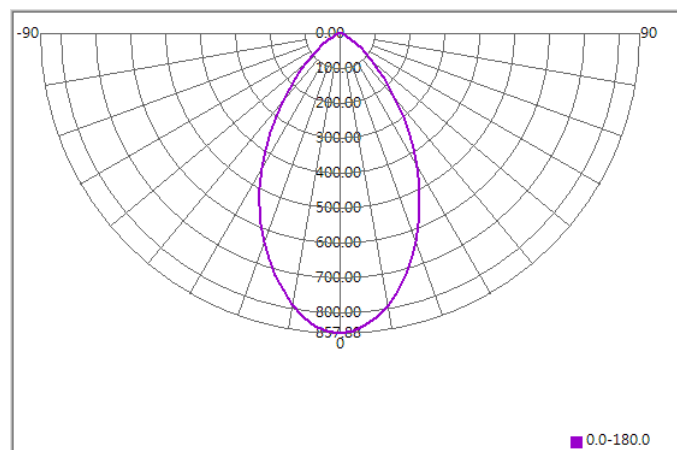

Illuminance At Distances

