



Product Model Number

CKO - M 4 1 2 - 0 3 5 0 1 1 - 1 8 0 1

✓ Model Number Definitions

CKO-XXXX-XXXXXX-XXXX



- A. Chun Kuang Optics Corp. Product
- B. Product Type: product abbreviation
Ex:
CH→CoB High Intensity
CC→CoB Compact
CS→Soft Shading for CoB LED
HC→Holder for CoB LED

- C. Identity Code
- D. Lens / Fixture Size
Ex: 075026=Φ75mm / Thickness=26mm (round up)
- C. Serial Numbers

The lens datasheet is applicable for **CREE LED**, that manufactured by Chun Kuang Optics Corp.

✓ Dimensions (mm) : Φ35 x 10.9

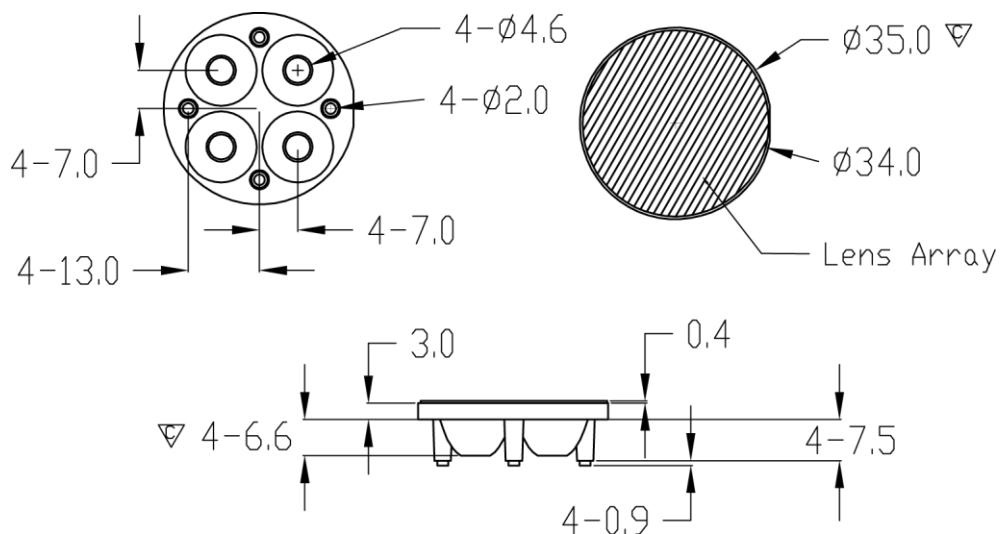

∇ :Critical Dimension



Optical Characteristics

Model Number	CKO-M412-035011-1801	
LED	XB-D	
LES / LED Size	Φ 2.5 x 2.5 mm	
FWHM (D50)	13°	
Field Angle (D10)	33°	
Dimension	Φ =35 mm, Thickness=10.9 mm	
Luminous Flux	307 lm	Measured @ 4.2 W
Material	PC / UL94V0	

cd/klm

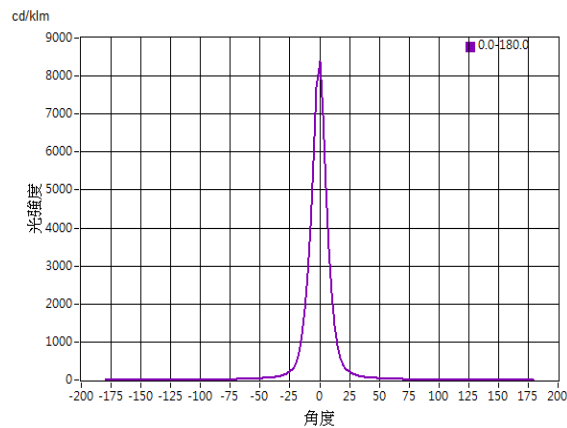

Illuminance At Distances

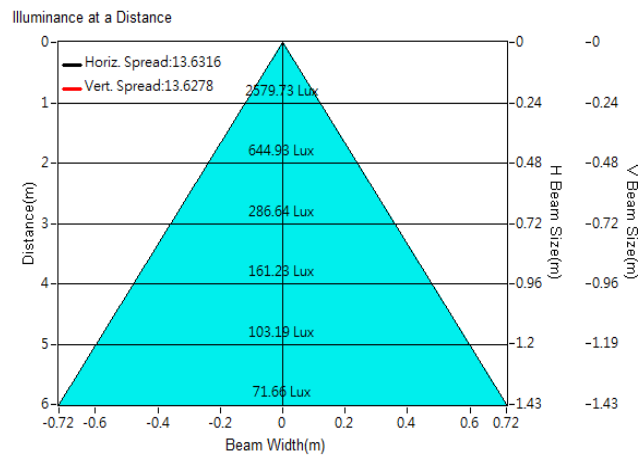



Optical Characteristics

Model Number	CKO-M412-035011-1801	
LED	XB-H	
LES / LED Size	Φ 2.5 x 2.5 mm	
FWHM (D50)	13°	
Field Angle (D10)	36°	
Dimension	Φ =35 mm, Thickness=10.9 mm	
Luminous Flux	442 lm	Measured @ 4 W
Material	PC / UL94V0	

cd/klm

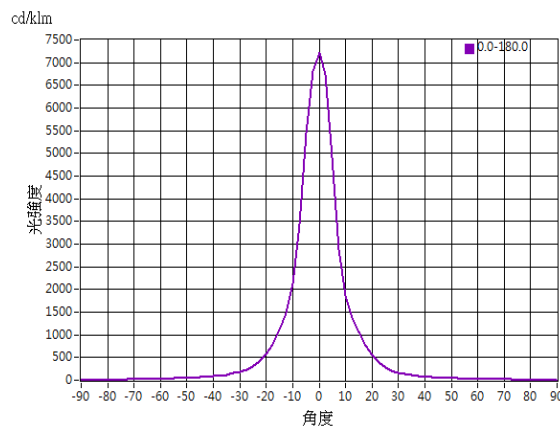

Illuminance At Distances

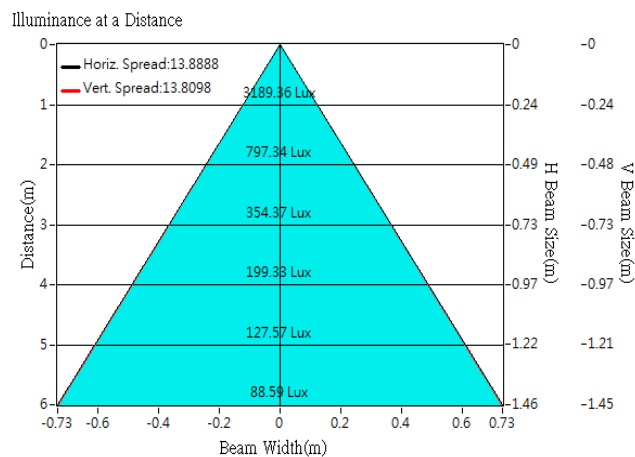



Optical Characteristics

Model Number	CKO-M412-035011-1801	
LED	XP-E	
LES / LED Size	Φ 3.5 x 3.5 mm	
FWHM (D50)	10°	
Field Angle (D10)	25°	
Dimension	Φ =35 mm, Thickness=10.9 mm	
Luminous Flux	288 lm	Measured @ 4.1 W
Material	PC / UL94V0	

cd/klm

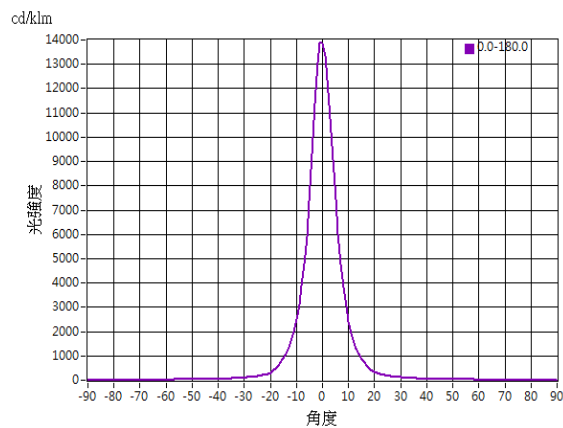

Illuminance At Distances

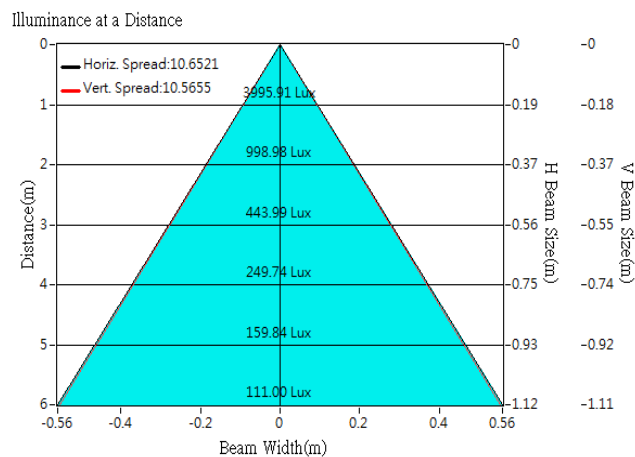



Optical Characteristics

Model Number	CKO-M412-035011-1801	
LED	XP-G	
LES / LED Size	Φ 3.5 x 3.5 mm	
FWHM (D50)	14°	
Field Angle (D10)	33°	
Dimension	Φ =35 mm, Thickness=10.9 mm	
Luminous Flux	347 lm	Measured @ 3.9 W
Material	PC / UL94V0	

cd/klm

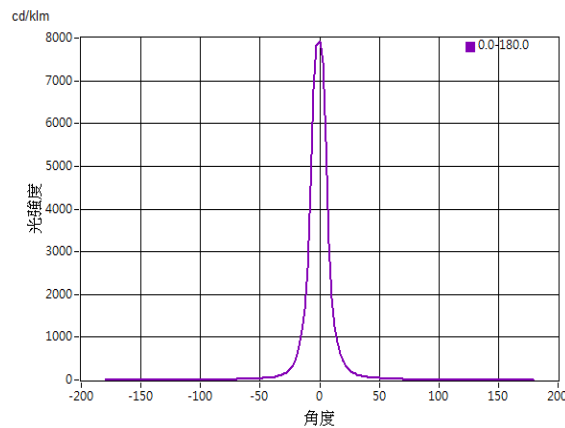

Illuminance At Distances

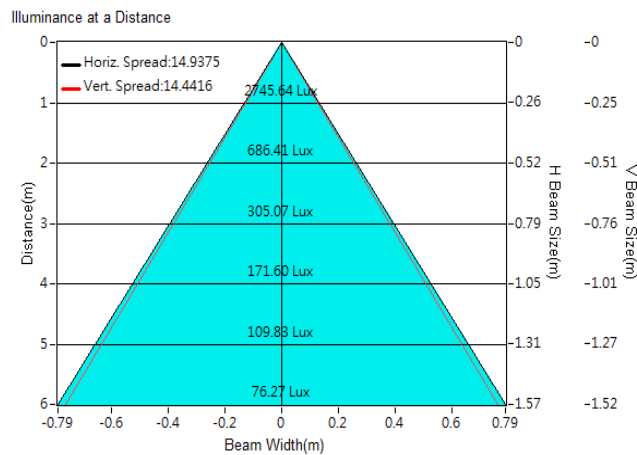



Optical Characteristics

Model Number	CKO-M412-035011-1801	
LED	XP-G2	
LES / LED Size	Φ 3.5 x 3.5 mm	
FWHM (D50)	13°	
Field Angle (D10)	35°	
Dimension	Φ =35 mm, Thickness=10.9 mm	
Luminous Flux	601 lm	Measured @ 5.5 W
Material	PC / UL94V0	

cd/klm

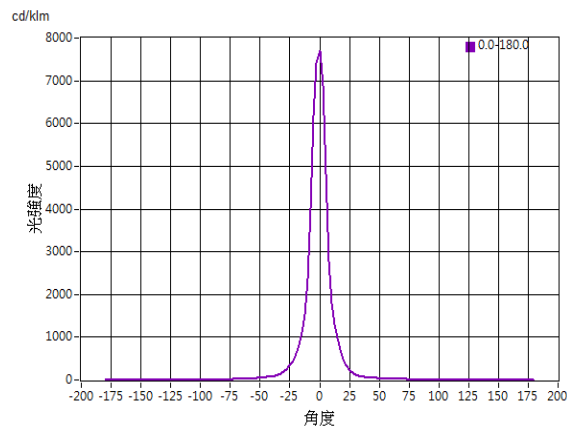

Illuminance At Distances

