



Product Model Number

CKO - M 5 1 2 - 0 3 9 0 1 1 - 7 1 0 1

✓ Model Number Definitions

CKO-XXXX-XXXXXX-XXXX



- A. Chun Kuang Optics Corp. Product
- B. Product Type: product abbreviation
Ex:
CH→CoB High Intensity
CC→CoB Compact
CS→Soft Shading for CoB LED
HC→Holder for CoB LED

- C. Identity Code
- D. Lens / Fixture Size
Ex: 075026=Φ75mm / Thickness=26mm (round up)
- C. Serial Numbers

The lens datasheet is applicable for **CREE LED**, that manufactured by Chun Kuang Optics Corp.

✓ Dimensions (mm) : Φ39 x 10.9

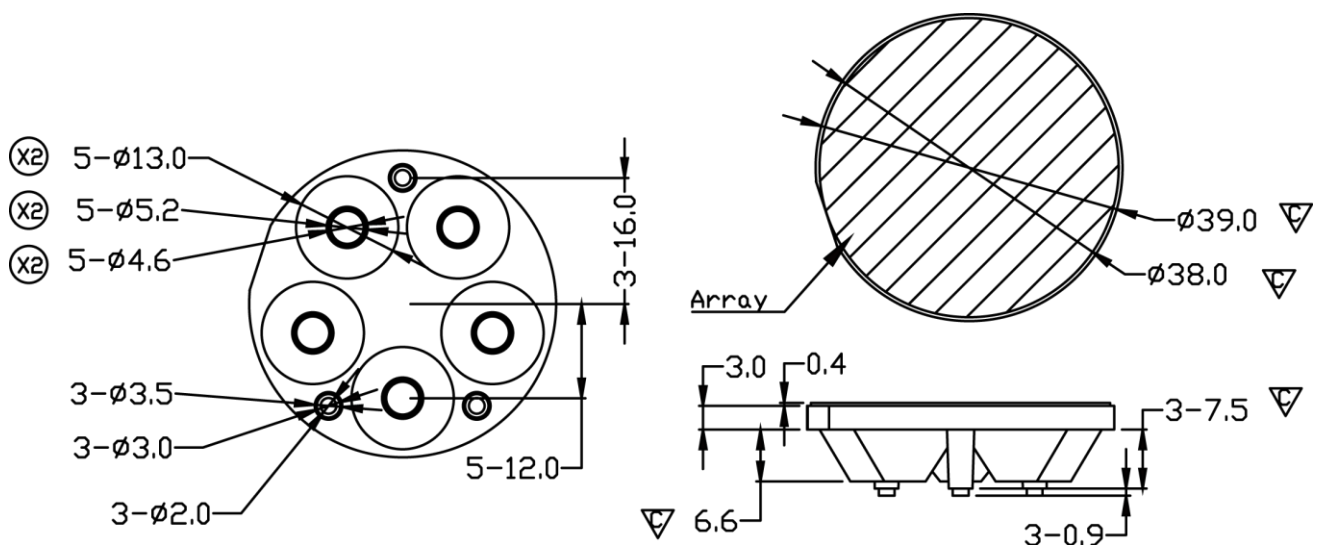

▽:Critical Dimension



Optical Characteristics

Model Number	CKO-M512-039011-7101	
LED	XB-D	
LES / LED Size	Φ 2.5 x 2.5 mm	
FWHM (D50)	28°	
Field Angle (D10)	56°	
Dimension	Φ =39 mm, Thickness=10.9 mm	
Luminous Flux	486 lm	Measured @ 5.2 W
Material	PC / UL94V0	

cd/klm

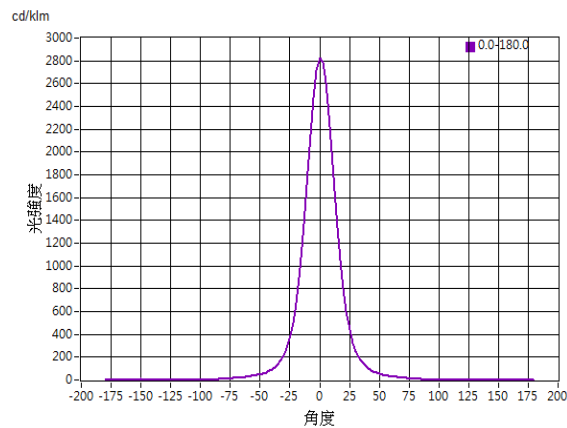

Illuminance At Distances

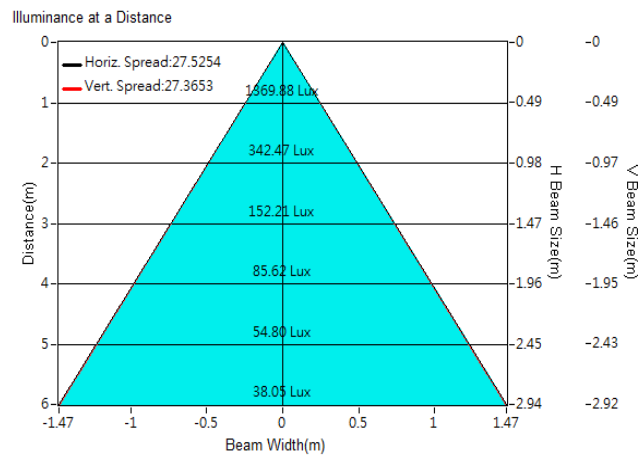



Optical Characteristics

Model Number	CKO-M512-039011-7101	
LED	XB-H	
LES / LED Size	Φ 2.5 x 2.5 mm	
FWHM (D50)	28°	
Field Angle (D10)	59°	
Dimension	Φ =39 mm, Thickness=10.9 mm	
Luminous Flux	561 lm	Measured @ 4.9 W
Material	PC / UL94V0	

cd/klm

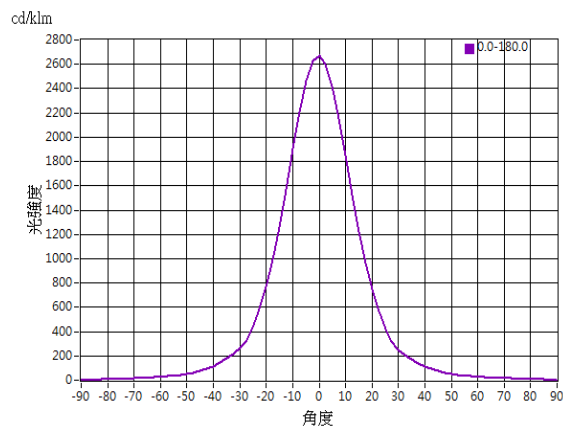

Illuminance At Distances

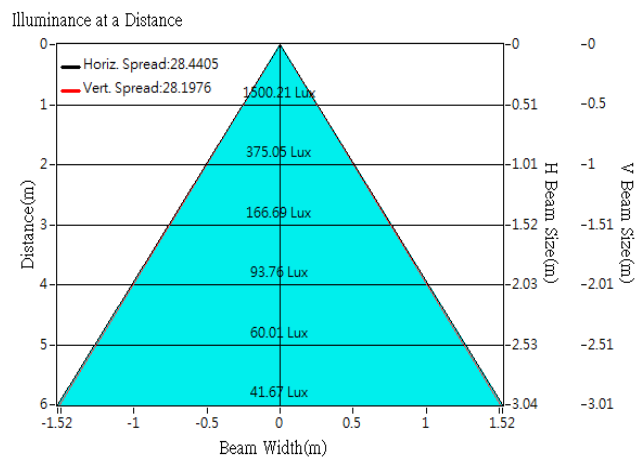



Optical Characteristics

Model Number	CKO-M512-039011-7101	
LED	XP-G	
LES / LED Size	Φ 3.5 x 3.5 mm	
FWHM (D50)	30°	
Field Angle (D10)	60°	
Dimension	Φ =39 mm, Thickness=10.9 mm	
Luminous Flux	441 lm	Measured @ 5 W
Material	PC / UL94V0	

cd/klm

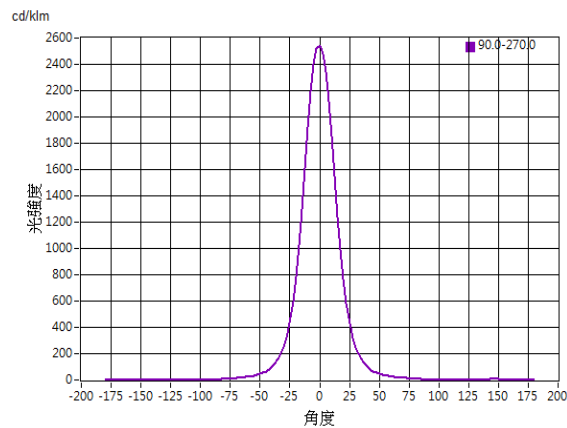

Illuminance At Distances

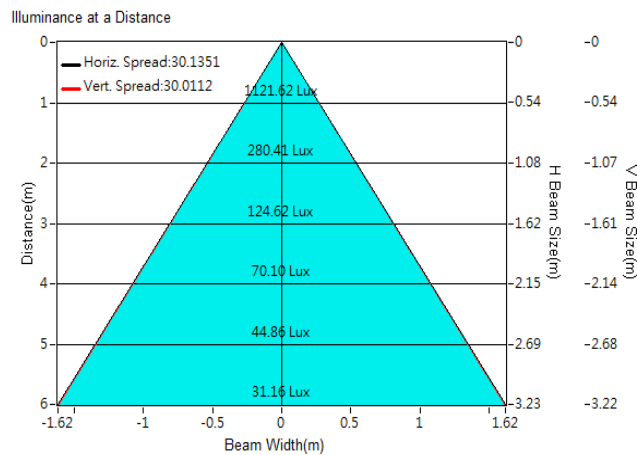



Optical Characteristics

Model Number	CKO-M512-039011-7101	
LED	XP-G2	
LES / LED Size	Φ 3.5 x 3.5 mm	
FWHM (D50)	29°	
Field Angle (D10)	58°	
Dimension	Φ =39 mm, Thickness=10.9 mm	
Luminous Flux	591 lm	Measured @ 4.9 W
Material	PC / UL94V0	

cd/klm

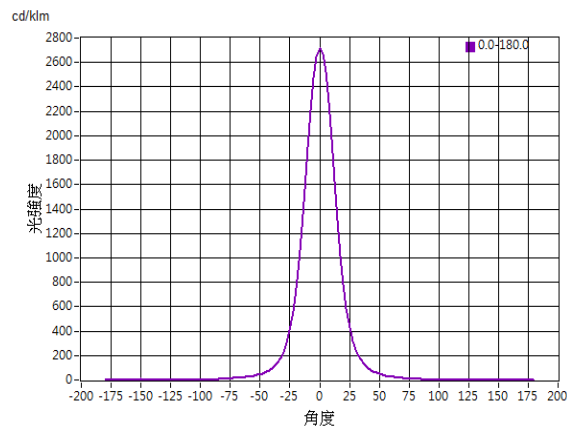

Illuminance At Distances

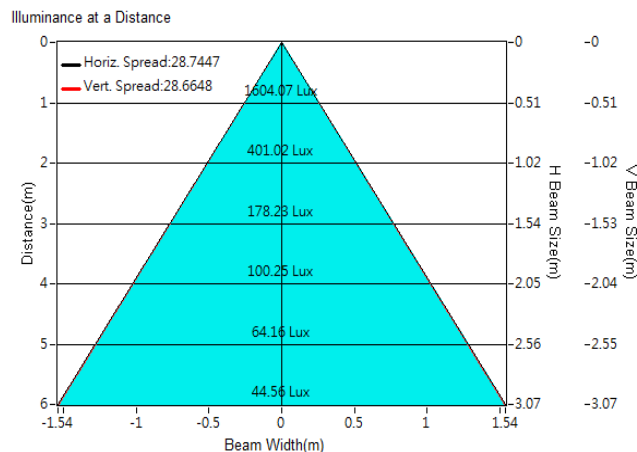



Optical Characteristics

Model Number	CKO-M512-039011-7101	
LED	XP-G3	
LES / LED Size	Φ 3.5 x 3.5 mm	
FWHM (D50)	29°	
Field Angle (D10)	60°	
Dimension	Φ =39 mm, Thickness=10.9 mm	
Luminous Flux	806 lm	Measured @ 4.9 W
Material	PC / UL94V0	

cd/klm

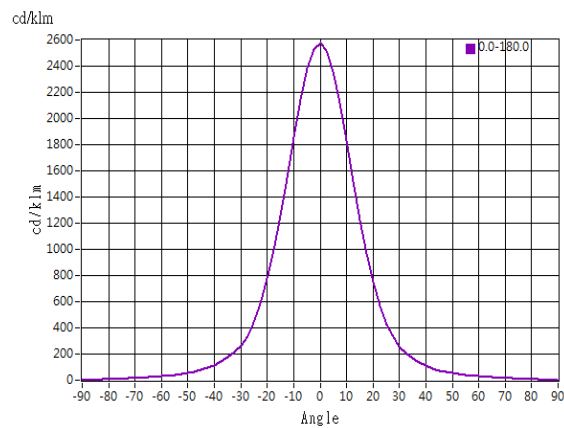

Illuminance At Distances

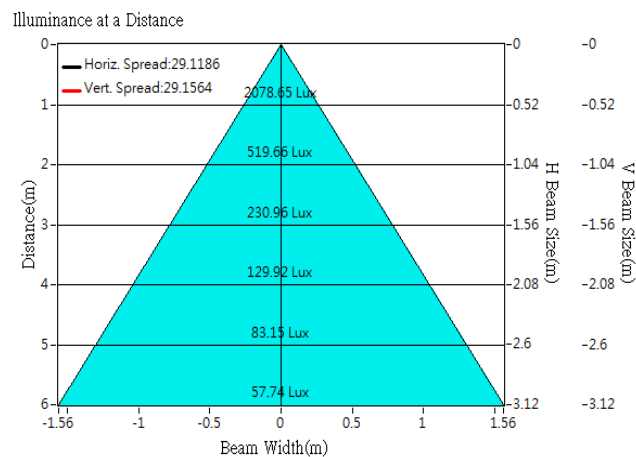



Optical Characteristics

Model Number	CKO-M512-039011-7101	
LED	XP-L	
LES / LED Size	Φ 3.5 x 3.5 mm	
FWHM (D50)	32°	
Field Angle (D10)	67°	
Dimension	Φ =39 mm, Thickness=10.9 mm	
Luminous Flux	2286 lm	Measured @ 15.9 W
Material	PC / UL94V0	

cd/klm

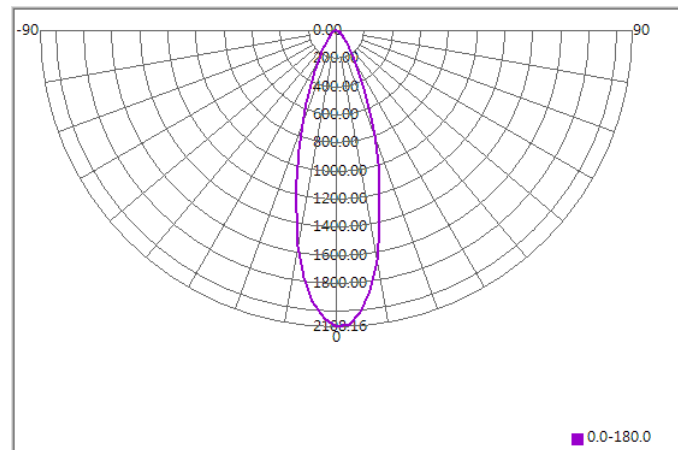

Illuminance At Distances

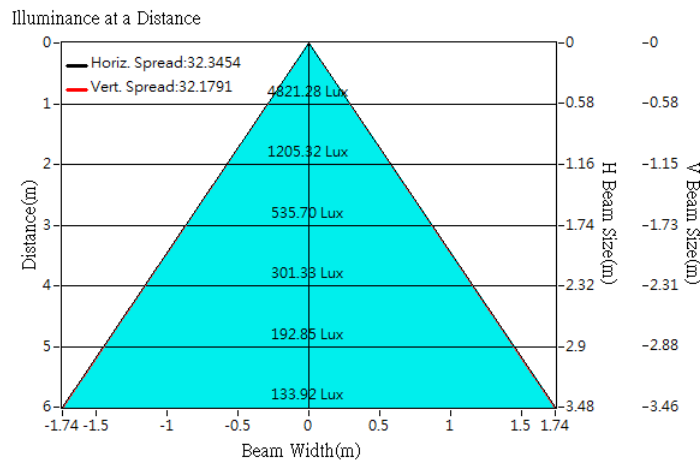



Optical Characteristics

Model Number	CKO-M512-039011-7101	
LED	XP-L HI	
LES / LED Size	Φ 3.5 x 3.5 mm	
FWHM (D50)	28°	
Field Angle (D10)	58°	
Dimension	Φ =39 mm, Thickness=10.9 mm	
Luminous Flux	2003 lm	Measured @ 16.0 W
Material	PC / UL94V0	

cd/klm

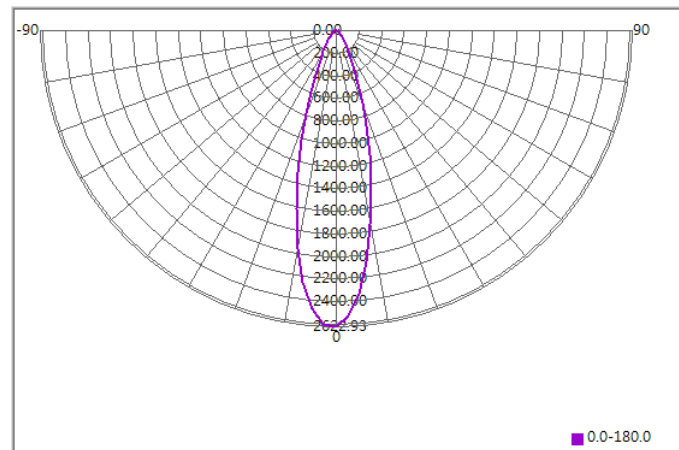

Illuminance At Distances

