



## Product Model Number

**CKO-SA17-045021-1309**

### ✓ Model Number Definitions

**CKO-XXXX-XXXXXX-XXXX**



- A. Chun Kuang Optics Corp. Product
- B. Product Type: product abbreviation  
Ex:  
CH→CoB High Intensity  
CC→CoB Compact  
CS→Soft Shading for CoB LED  
HC→Holder for CoB LED

- C. Identity Code
- D. Lens / Fixture Size  
Ex: 075026=Φ75mm / Thickness=26mm (round up)
- C. Serial Numbers

The lens datasheet is applicable for **Philips LED**, that manufactured by Chun Kuang Optics Corp.

### ✓ Dimensions (mm) : Φ45 x 20.9

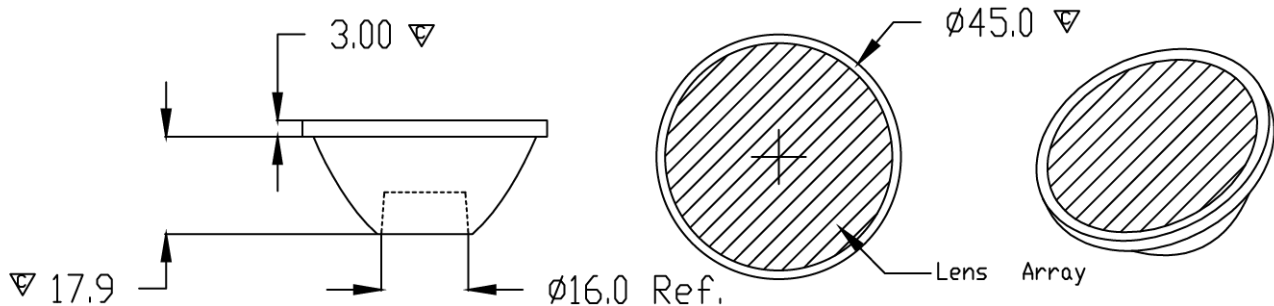

▽:Critical Dimension





## Optical Characteristics

|                   |                             |                  |  |
|-------------------|-----------------------------|------------------|--|
| Model Number      | CKO-SA17-045021-1309        |                  |  |
| LED               | Fortimo SLM 1202 L06 G7     |                  |  |
| LES / LED Size    | Φ 6.5 mm                    |                  |  |
| FWHM (D50)        | 14°x35°                     |                  |  |
| Field Angle (D10) | 35°x61°                     |                  |  |
| H (distance)      | 2.5 mm                      |                  |  |
| Dimension         | Φ =45 mm, Thickness=20.9 mm |                  |  |
| Luminous Flux     | 1036 lm                     | Measured @ 7.0 W |  |
| Material          | PC / UL94V2                 |                  |  |

## cd/klm

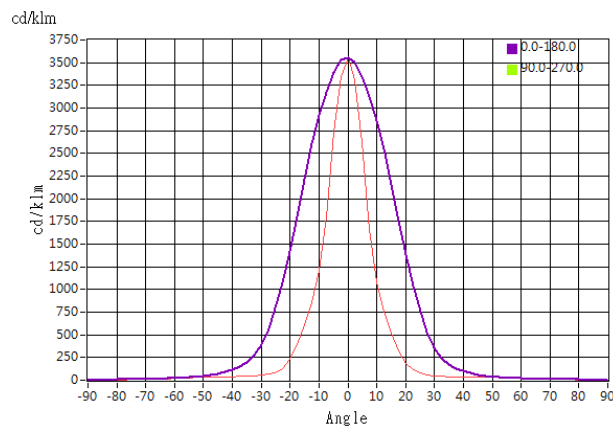

## Illuminance At Distances

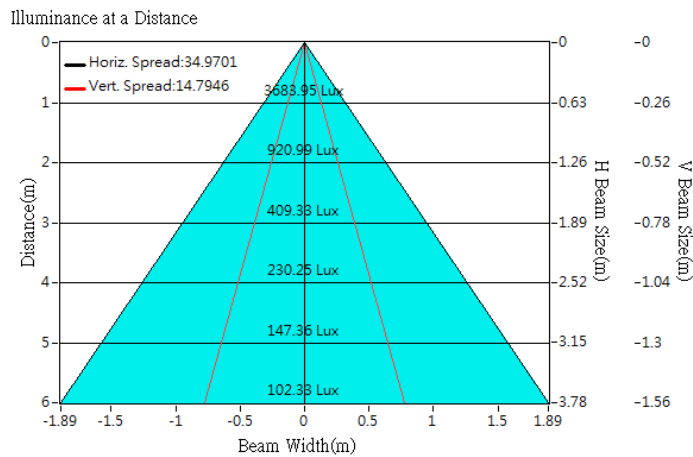



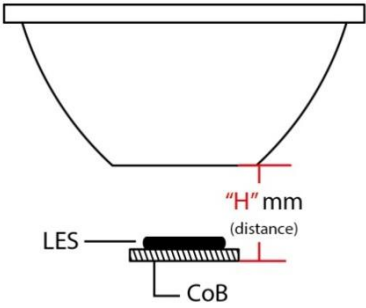

## Optical Characteristics

|                   |                             |                  |  |
|-------------------|-----------------------------|------------------|--|
| Model Number      | CKO-SA17-045021-1309        |                  | <p>"H" definition</p>  |
| LED               | Fortimo SLM 1202 L06 G6     |                  |  |
| LES / LED Size    | Φ 6.5 mm                    |                  |  |
| FWHM (D50)        | 15°x34°                     |                  |  |
| Field Angle (D10) | 36°x60°                     |                  |  |
| H (distance)      | 2.5mm                       |                  |  |
| Dimension         | Φ =45 mm, Thickness=20.9 mm |                  |  |
| Luminous Flux     | 979 lm                      | Measured @ 7.0 W |  |
| Material          | PC / UL94V2                 |                  |  |

## cd/klm

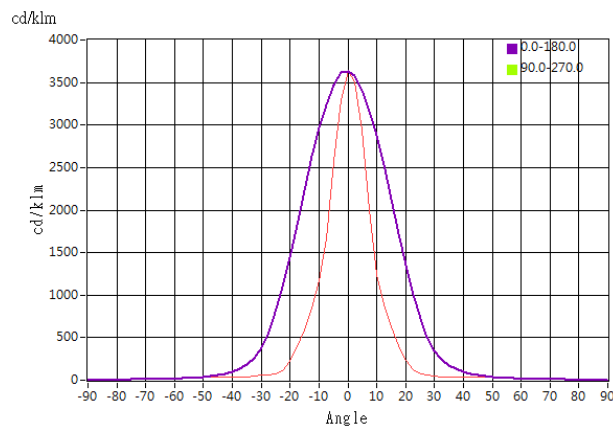

## Illuminance At Distances

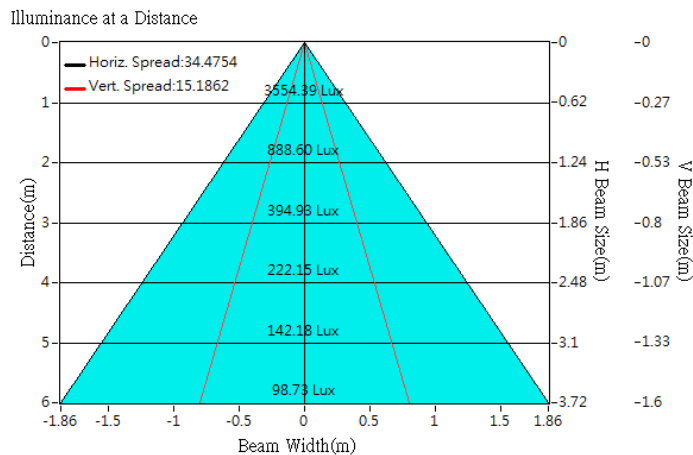



## Optical Characteristics

|                   |                             |                   |                       |
|-------------------|-----------------------------|-------------------|-----------------------|
| Model Number      | CKO-SA17-045021-1309        |                   | <p>"H" definition</p> |
| LED               | Fortimo SLM 1203 L09 G6     |                   |                       |
| LES / LED Size    | Φ 9 mm                      |                   |                       |
| FWHM (D50)        | 18°x35°                     |                   |                       |
| Field Angle (D10) | 42°x65°                     |                   |                       |
| H (distance)      | 2.5mm                       |                   |                       |
| Dimension         | Φ =45 mm, Thickness=20.9 mm |                   |                       |
| Luminous Flux     | 1307 lm                     | Measured @ 10.4 W |                       |
| Material          | PC / UL94V2                 |                   |                       |

## cd/klm

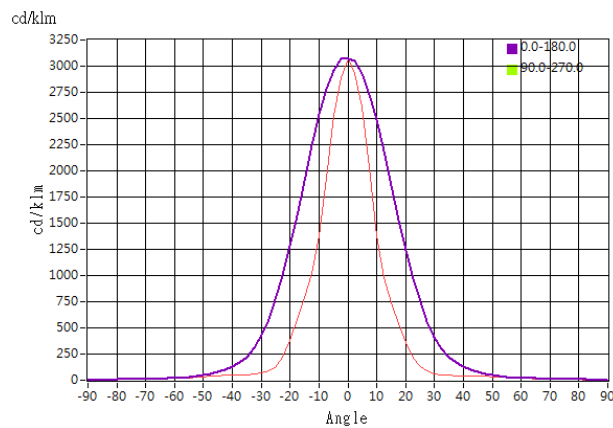

## Illuminance At Distances

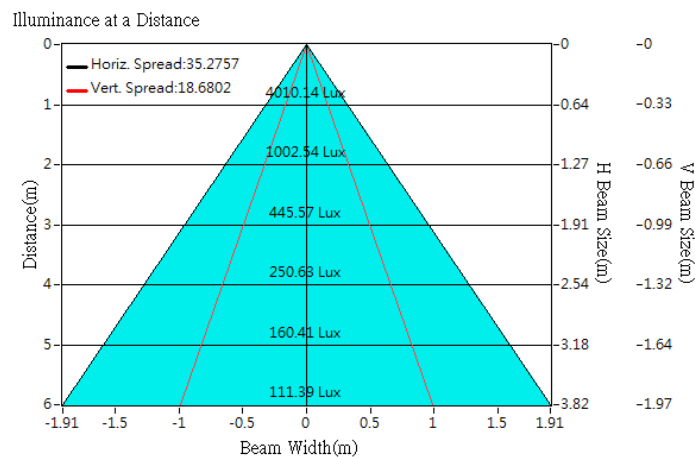



## Optical Characteristics

|                   |                                   |                   |  |
|-------------------|-----------------------------------|-------------------|--|
| Model Number      | CKO-SA17-045021-1309              |                   |  |
| LED               | Fortimo SLM C 1203 L09 1619 G6_DL |                   |  |
| LES / LED Size    | Φ 9 mm                            |                   |  |
| FWHM (D50)        | 18°x36°                           |                   |  |
| Field Angle (D10) | 44°x66°                           |                   |  |
| H (distance)      | 3.5mm                             |                   |  |
| Dimension         | Φ =45 mm, Thickness=20.9 mm       |                   |  |
| Luminous Flux     | 1256 lm                           | Measured @ 10.4 W |  |
| Material          | PC / UL94V2                       |                   |  |

## cd/klm

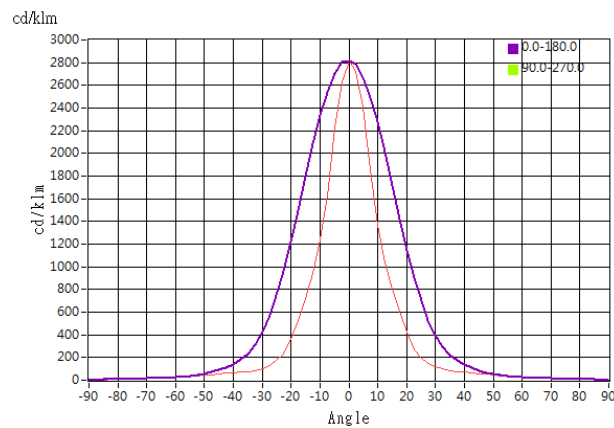

## Illuminance At Distances

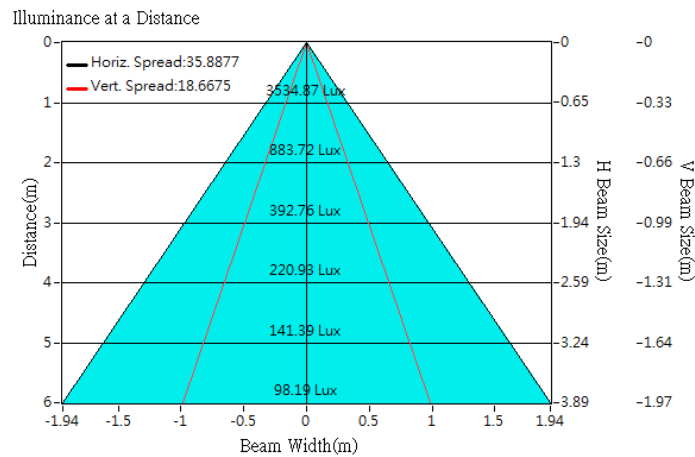





## Optical Characteristics

|                   |                                   |                   |  |
|-------------------|-----------------------------------|-------------------|--|
| Model Number      | CKO-SA17-045021-1309              |                   |  |
| LED               | Fortimo SLM C 1203 L09 1619 G6_PI |                   |  |
| LES / LED Size    | Φ 9 mm                            |                   |  |
| FWHM (D50)        | 18°x36°                           |                   |  |
| Field Angle (D10) | 44°x66°                           |                   |  |
| H (distance)      | 3.5mm                             |                   |  |
| Dimension         | Φ =45 mm, Thickness=20.9 mm       |                   |  |
| Luminous Flux     | 1256 lm                           | Measured @ 10.4 W |  |
| Material          | PC / UL94V2                       |                   |  |

## cd/klm

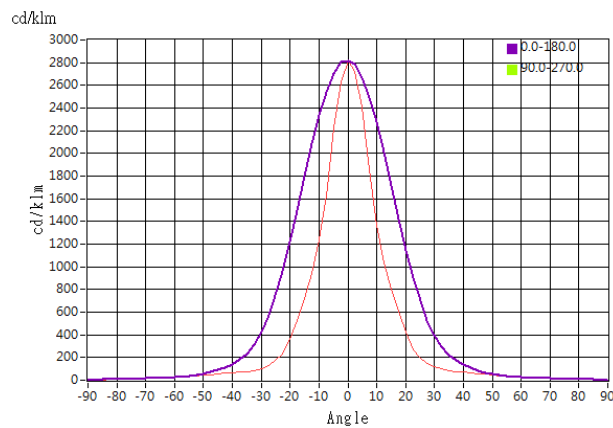

## Illuminance At Distances

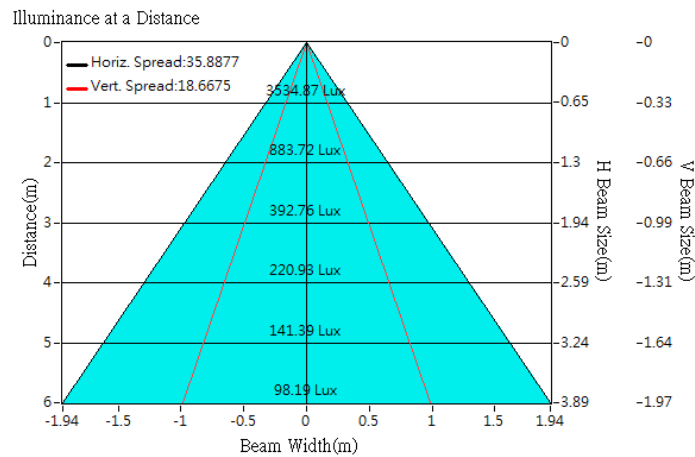



## Optical Characteristics

|                   |                             |                   |                       |
|-------------------|-----------------------------|-------------------|-----------------------|
| Model Number      | CKO-SA17-045021-1309        |                   | <p>"H" definition</p> |
| LED               | Fortimo SLM PW 1204 L09 G7  |                   |                       |
| LES / LED Size    | Φ 9 mm                      |                   |                       |
| FWHM (D50)        | 18°x35°                     |                   |                       |
| Field Angle (D10) | 41°x65°                     |                   |                       |
| H (distance)      | 2.5mm                       |                   |                       |
| Dimension         | Φ =45 mm, Thickness=20.9 mm |                   |                       |
| Luminous Flux     | 2263 lm                     | Measured @ 21.6 W |                       |
| Material          | PC / UL94V2                 |                   |                       |

## cd/klm

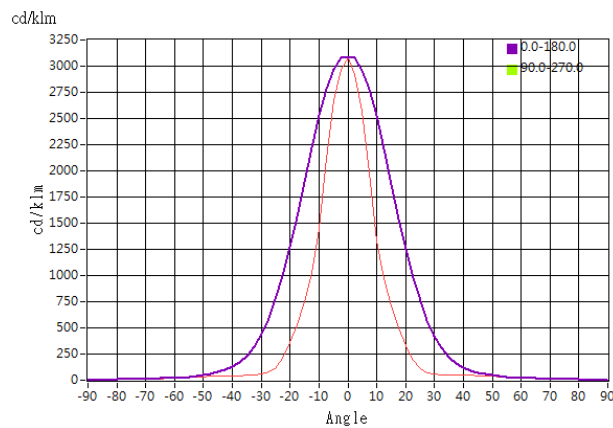

## Illuminance At Distances

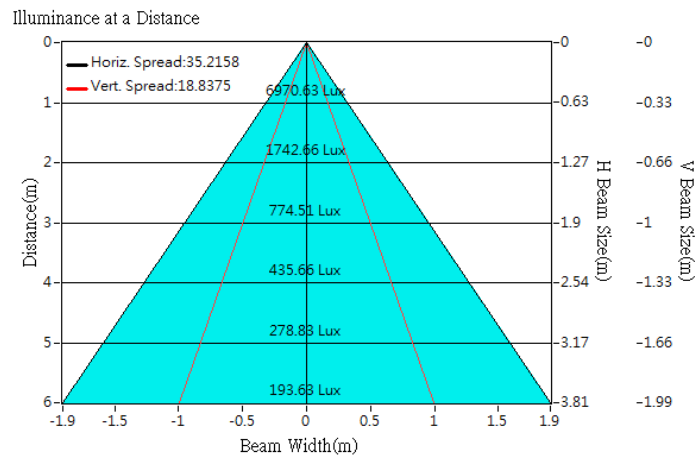





## Optical Characteristics

|                   |                             |                  |                       |
|-------------------|-----------------------------|------------------|-----------------------|
| Model Number      | CKO-SA17-045021-1309        |                  | <p>"H" definition</p> |
| LED               | Fortimo SLM 1202 L09 G7N    |                  |                       |
| LES / LED Size    | Φ 9.8 mm                    |                  |                       |
| FWHM (D50)        | 21°x35°                     |                  |                       |
| Field Angle (D10) | 46°x67°                     |                  |                       |
| H (distance)      | 2.5mm                       |                  |                       |
| Dimension         | Φ =45 mm, Thickness=20.9 mm |                  |                       |
| Luminous Flux     | 872 lm                      | Measured @ 6.1 W |                       |
| Material          | PC / UL94V2                 |                  |                       |

## cd/klm

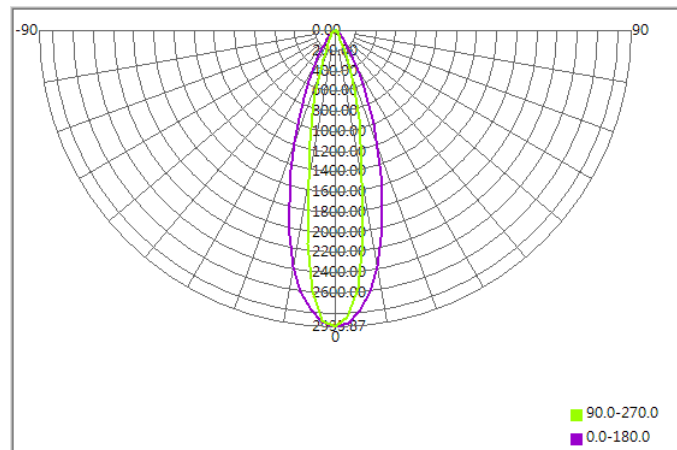

## Illuminance At Distances

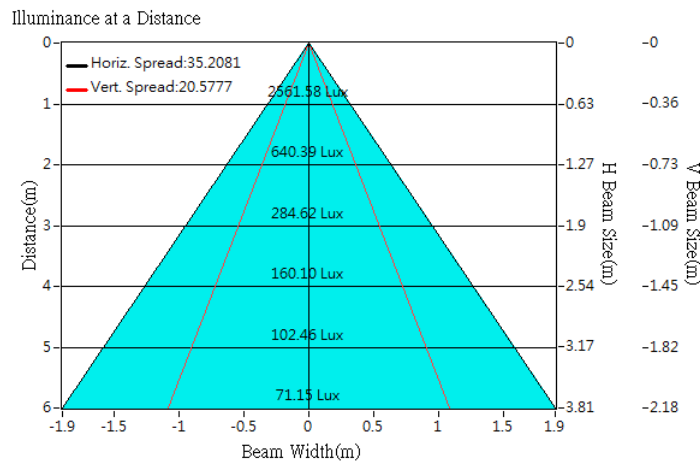



## Optical Characteristics

|                   |                             |                  |  |
|-------------------|-----------------------------|------------------|--|
| Model Number      | CKO-SA17-045021-1309        |                  |  |
| LED               | Fortimo SLM 1203 L09 G7N    |                  |  |
| LES / LED Size    | Φ 9.8 mm                    |                  |  |
| FWHM (D50)        | 22°x36°                     |                  |  |
| Field Angle (D10) | 45°x69°                     |                  |  |
| H (distance)      | 2.5mm                       |                  |  |
| Dimension         | Φ =45 mm, Thickness=20.9 mm |                  |  |
| Luminous Flux     | 1329 lm                     | Measured @ 9.2 W |  |
| Material          | PC / UL94V2                 |                  |  |

## cd/klm

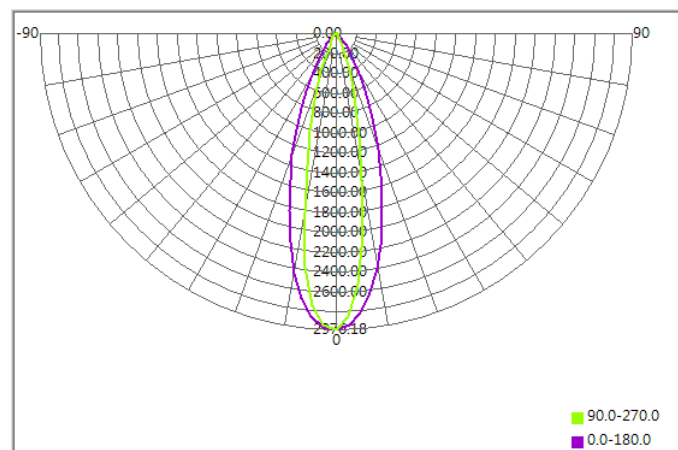

## Illuminance At Distances

